





Bohren

HSS-Bohrer

1

VHM-Bohrer

Reibahlen

Gewinde

Gewindebohrer

2

Zirkular- und Gewindefräser

Gewindedrehwerkzeuge

Drehen

Wendeplattendrehwerkzeuge

3

EcoCut

Stechwerkzeuge

Miniaturdrehwerkzeuge

Fräsen

VHM-Fräser

4

Spannen

5

Materialbeispiele und
Artikel-Nr.-Verzeichnis

6

Inhaltsverzeichnis

Übersicht	2
Produktprogramm	3-32
Technische Informationen	33

WNT MASTERTOOL
PERFORMANCE

Premium-Qualitätswerkzeuge für höchste Performance.

Die Premium-Qualitätswerkzeuge aus der Produktlinie **WNT Mastertool Performance** wurden für spezielle Anwendungen konzipiert und zeichnen sich durch ihre herausragende Leistungsfähigkeit aus. Wenn Sie in Ihrer Fertigung höchste Ansprüche an die Performance stellen und allerbeste Ergebnisse erzielen wollen, dann empfehlen wir Ihnen die Premiumwerkzeuge aus dieser Produktlinie.

Übersicht

Druckspannzangen



→ 3-11

Druckspannzangen zur Klemmung der Stange auf der Hauptseite sowie zur Klemmung in der Abgreifspindel

Führungsbuchsen



→ 15-24

Gewährleistet die Führung der Stange auf der Hauptseite

Vorbauspannzangen



→ 12-14

Mit angepasstem Vorbau zum besseren Abgreifen der Werkstücke und zur besseren Bearbeitbarkeit auf der Rückseite

Spannhülsen



→ 25-32

Lagerung für Lademagazine von Stangenladern

i Weitere Profilformen und Größen sowie erweiterte Optionen auf Anfrage lieferbar.

Highlights

- Präzision „Made in Germany“
verlässliche Qualität
- höchste Rundlaufgenauigkeiten
verringert Vibrationen
- in Querrillen-Ausführung erhältlich
steigert die Haltekräfte signifikant
- alle relevanten Flächen sind
„präzisionsgeschliffen“
erhöht die Bauteilgenauigkeit
- in glatter Ausführung erhältlich
keine Abdrücke auf dem Werkstück

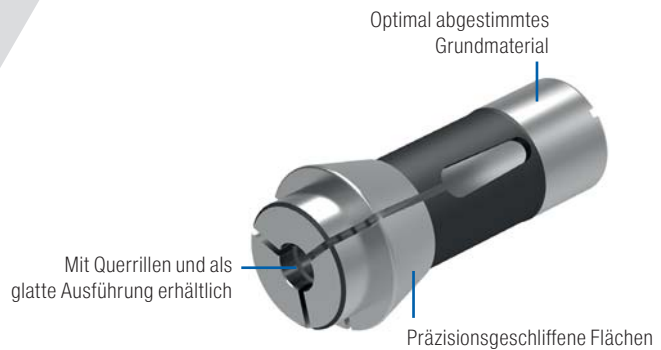

Übersicht Druckspannzangen

Norm	Bereich Klemmdurchmesser in mm	Profil	Ausführung	Seite
116E	Ø 6,0 - 10,0	●	Querrillen	4
	Ø 1,0 - 10,0		Glatt	4
120E	Ø 6,0 - 12,0	●	Querrillen	4
	Ø 1,0 - 12,0		Glatt	4
F16	Ø 1,0 - 13,0	●	Querrillen	5
	Ø 6,0 - 13,0		Glatt	5
136E	Ø 6,0 - 16,0	●	Querrillen	6
	Ø 1,0 - 16,0		Glatt	6
138E	Ø 6,0 - 16,0	●	Querrillen	6
	Ø 1,0 - 16,0		Glatt	6
145E	Ø 6,0 - 20,0	●	Querrillen	7+8
	Ø 1,5 - 20,0		Glatt	7+8
F37	Ø 6,0 - 32,0	●	Querrillen	9-11
	Ø 1,0 - 32,0		Glatt	9-11
120E	SW 2,0 - 11,0	⬡	Querrillen*	4
138E	SW 2,0 - 14,0	⬡	Querrillen*	6
145E	SW 2,0 - 19,0	⬡	Querrillen*	7+8
F37	SW 3,0 - 27,0	⬡	Querrillen*	9-11
145E	SW 2,0 - 15,0	■	Querrillen*	7+8
F37	SW 3,0 - 23,0	■	Querrillen*	9-11

* Querrillen erst ab SW 8

Druckspannzangen

Bezeichnung	d DGUI mm	D DFC mm	A DCLC mm	I LCLC mm	L ₁ OAL mm	K°
116 E / F 13	13	19	13	6	64	16
120 E / F 15	15	21	15	6	64	16

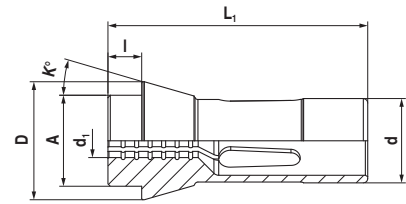

116 E / F 13

120 E / F 15



● Querrillen
116 E / F 13

● Glatt
116 E / F 13

d ₁ DCONWS mm	NEW Y8	NEW Y8
	Bestell Nr. 81 000 ... EUR	Bestell Nr. 81 002 ... EUR
1,0		134,50 01000
1,5		134,50 01500
2,0		134,50 02000
2,5		134,50 02500
3,0		46,06 03000
3,5		46,06 03500
4,0		46,06 04000
4,5		46,06 04500
5,0		46,06 05000
5,5		46,06 05500
6,0	46,06 06000	65,73 06000
6,5	46,06 06500	65,73 06500
7,0	46,06 07000	65,73 07000
7,5	46,06 07500	65,73 07500
8,0	46,06 08000	65,73 08000
8,5	46,06 08500	65,73 08500
9,0	46,06 09000	65,73 09000
9,5	46,06 09500	65,73 09500
10,0	46,06 10000	65,73 10000



● Querrillen
120 E / F 15

● Glatt
120 E / F 15

● Querrillen
120 E / F 15

d ₁ DCONWS mm	d ₁ Zoll	NEW Y8	NEW Y8	NEW Y8
		Bestell Nr. 81 003 ... EUR	Bestell Nr. 81 005 ... EUR	Bestell Nr. 81 031 ... EUR
1,000			93,34 01000	
1,500			93,34 01500	
2,000			50,64 02000	178,30 02000 ¹⁾
2,500			50,64 02500	
3,000			30,88 03000	178,30 03000 ¹⁾
3,175	1/8			178,30 03175 ¹⁾
3,500			30,88 03500	
4,000			30,88 04000	94,97 04000 ¹⁾
4,500			30,88 04500	
5,000			30,88 05000	94,97 05000 ¹⁾
5,500			30,88 05500	
6,000		30,88 06000	50,64 06000	94,97 06000 ¹⁾
6,350	1/4			136,70 06350 ¹⁾
6,500		30,88 06500	50,64 06500	
7,000		30,88 07000	50,64 07000	94,97 07000 ¹⁾
7,500		30,88 07500	50,64 07500	
8,000		30,88 08000	50,64 08000	94,97 08000
8,500		30,88 08500	50,64 08500	
9,000		30,88 09000	50,64 09000	94,97 09000
9,500			50,64 09500	
10,000		30,88 10000	50,64 10000	114,10 10000
10,500		30,88 10500	50,64 10500	
11,000		30,88 11000	50,64 11000	198,70 11000
11,500		30,88 11500	50,64 11500	
12,000		30,88 12000	50,64 12000	

1) Ohne Querrillen

Druckspannzangen

Bezeichnung	d DGUI mm	D DFC mm	A DCLC mm	I LCLC mm	L _T OAL mm	K°
F 16 / 1212 E	16	21	16	6	64	16

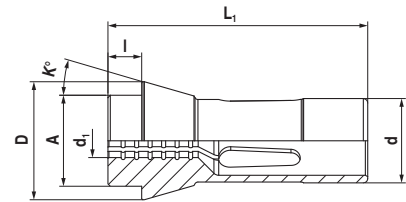

F 16 / 1212 E



● Querrillen

F 16 / 1212 E

● Glatt

F 16 / 1212 E

d ₁ DCONWS mm	NEW Y8 Bestell Nr. 81 019 ... EUR		NEW Y8 Bestell Nr. 81 021 ... EUR	
	1,0			71,02
1,5			71,02	01500
2,0			71,02	02000
2,5			71,02	02500
3,0			46,06	03000
3,5			46,06	03500
4,0			46,06	04000
4,5			46,06	04500
5,0			46,06	05000
5,5			46,06	05500
6,0	46,06	06000	65,73	06000
6,5	46,06	06500	65,73	06500
7,0	46,06	07000	65,73	07000
7,5	46,06	07500	65,73	07500
8,0	46,06	08000	65,73	08000
8,5	46,06	08500	65,73	08500
9,0	46,06	09000	65,73	09000
9,5	46,06	09500	65,73	09500
10,0	46,06	10000	65,73	10000
10,5	46,06	10500	65,73	10500
11,0	46,06	11000	65,73	11000
11,5	46,06	11500	65,73	11500
12,0	46,06	12000	65,73	12000
12,5	46,06	12500	65,73	12500
13,0	46,06	13000	65,73	13000

Druckspannzangen

Bezeichnung	d DGUI mm	D DFC mm	A DCLC mm	I LCLC mm	L ₁ OAL mm	K°
136 E / F 20-201	20	26	19	5	54	15
138 E / F20-87	20	28	21	7	67	16

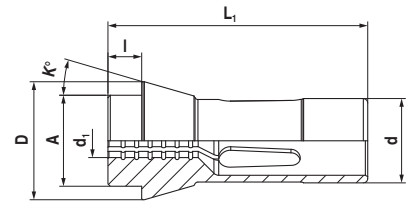

136 E / F 20-201



d ₁ DCONWS mm	Querrillen 136 E / F 20-201		Glatt 136 E / F 20-201	
	NEW Y8 Bestell Nr. 81 007 ... EUR		NEW Y8 Bestell Nr. 81 009 ... EUR	
1,0			115,20	01000
1,5			115,20	01500
2,0			75,00	02000
2,5			75,00	02500
3,0			46,06	03000
3,5			46,06	03500
4,0			46,06	04000
4,5			46,06	04500
5,0			46,06	05000
5,5			46,06	05500
6,0	46,06	06000	65,73	06000
6,5	46,06	06500	65,73	06500
7,0	46,06	07000	65,73	07000
7,5	46,06	07500	65,73	07500
8,0	46,06	08000	65,73	08000
8,5	46,06	08500	65,73	08500
9,0	46,06	09000	65,73	09000
9,5	46,06	09500	65,73	09500
10,0	46,06	10000	65,73	10000
10,5	46,06	10500	65,73	10500
11,0	46,06	11000	65,73	11000
11,5	46,06	11500	65,73	11500
12,0	46,06	12000	65,73	12000
12,5	46,06	12500	65,73	12500
13,0	46,06	13000	65,73	13000
13,5	46,06	13500	65,73	13500
14,0	46,06	14000	65,73	14000
14,5	46,06	14500	65,73	14500
15,0	46,06	15000	65,73	15000
15,5	46,06	15500	65,73	15500
16,0	46,06	16000	65,73	16000

138 E / F20-87



d ₁ DCONWS mm	d ₁ Zoll	Querrillen 138 E / F20-87		Glatt 138 E / F20-87		Querrillen 138 E / F20-87	
		NEW Y8 Bestell Nr. 81 011 ... EUR		NEW Y8 Bestell Nr. 81 013 ... EUR		NEW Y8 Bestell Nr. 81 026 ... EUR	
1,00				117,20	01000		
1,50				117,20	01500		
2,00				64,40	02000	236,40	02000 ¹⁾
2,50				64,40	02500		
3,00				46,06	03000	112,10	03000 ¹⁾
3,50				46,06	03500		
4,00				46,06	04000	112,10	04000 ¹⁾
4,50				46,06	04500		
5,00				46,06	05000	112,10	05000 ¹⁾
5,50				46,06	05500		
6,00		46,06	06000	65,73	06000	112,10	06000 ¹⁾
6,35	1/4					154,30	06350 ¹⁾
6,50		46,06	06500	65,73	06500		
7,00		46,06	07000	65,73	07000	88,65	07000 ¹⁾
7,50		46,06	07500	65,73	07500		
8,00		46,06	08000	65,73	08000	88,65	08000
8,50		46,06	08500	65,73	08500		
9,00		46,06	09000	65,73	09000	88,65	09000
9,50		46,06	09500	65,73	09500		
10,00		46,06	10000	65,73	10000	88,65	10000
10,50		46,06	10500	65,73	10500		
11,00		46,06	11000	65,73	11000	88,65	11000
11,50		46,06	11500	65,73	11500		
12,00		46,06	12000	65,73	12000	88,65	12000
12,50		46,06	12500	65,73	12500		
13,00		46,06	13000	65,73	13000	88,65	13000
13,50		46,06	13500	65,73	13500		
14,00		46,06	14000	65,73	14000	88,65	14000
14,50		46,06	14500	65,73	14500		
15,00		46,06	15000	65,73	15000		
15,50		46,06	15500	65,73	15500		
16,00		46,06	16000	65,73	16000		

1) Ohne Querrillen

Druckspannzangen

Bezeichnung	d DGUI mm	D DFC mm	A DCLC mm	I LCLC mm	L ₁ OAL mm	K°
145 E / F 25	25	35	27	10	77	16

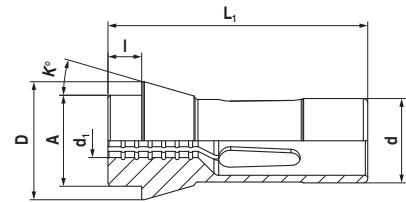

145 E / F 25



d ₁ DCONWS mm	d ₁ Zoll	● Querrillen 145 E / F 25		● Glatt 145 E / F 25		◻ Querrillen 145 E / F 25		◻ Querrillen 145 E / F 25	
		NEW Y8 Bestell Nr. 81 015 ... EUR		NEW Y8 Bestell Nr. 81 017 ... EUR		NEW Y8 Bestell Nr. 81 027 ... EUR		NEW Y8 Bestell Nr. 81 029 ... EUR	
1,500				77,55	01500				
1,501 - 1,999				90,69	xxxxx ²⁾				
2,000				77,55	02000	258,80	02000 ¹⁾	327,10	02000 ¹⁾
2,001 - 2,499				90,69	xxxxx ²⁾				
2,500				77,55	02500				
2,501 - 2,999				90,69	xxxxx ²⁾				
3,000				55,23	03000	198,70	03000 ¹⁾	163,00	03000 ¹⁾
3,001 - 3,499				90,69	xxxxx ²⁾				
3,500				55,23	03500				
3,501 - 3,999				90,69	xxxxx ²⁾				
4,000				55,23	04000	153,90	04000 ¹⁾	117,20	04000 ¹⁾
4,001 - 4,499				90,69	xxxxx ²⁾				
4,500				55,23	04500				
4,501 - 4,999				90,69	xxxxx ²⁾				
5,000				55,23	05000	117,20	05000 ¹⁾	117,20	05000 ¹⁾
5,001 - 5,499				90,69	xxxxx ²⁾				
5,500				55,23	05500				
5,501 - 5,999				90,69	xxxxx ²⁾				
6,000				55,23	06000	117,20	06000 ¹⁾	117,20	06000 ¹⁾
6,001 - 6,349				90,69	xxxxx ²⁾				
6,350	1/4			90,69	06350	159,10	06350 ¹⁾		
6,351 - 6,499				90,69	xxxxx ²⁾				
6,500				55,23	06500	75,00	06500		
6,501 - 6,999				90,69	xxxxx ²⁾				
7,000				55,23	07000	75,00	07000	91,00	07000 ¹⁾
7,001 - 7,499				90,69	xxxxx ²⁾			91,00	07000 ¹⁾
7,500				55,23	07500	75,00	07500		
7,501 - 7,937				90,69	xxxxx ²⁾				
7,938	5/16			90,69	07938	73,60	07938		
7,939 - 7,999				90,69	xxxxx ²⁾				
8,000				55,23	08000	75,00	08000	91,00	08000
8,001 - 8,499				90,69	xxxxx ²⁾			91,00	08000
8,500				55,23	08500	75,00	08500		
8,501 - 8,999				90,69	xxxxx ²⁾				
9,000				55,23	09000	75,00	09000	91,00	09000
9,001 - 9,499				90,69	xxxxx ²⁾			91,00	09000
9,500				55,23	09500	75,00	09500		
9,501 - 9,999				90,69	xxxxx ²⁾				
10,000				55,23	10000	75,00	10000	91,00	10000
10,001 - 10,499				90,69	xxxxx ²⁾			91,00	10000
10,500				55,23	10500	75,00	10500		
10,501 - 10,999				90,69	xxxxx ²⁾				
11,000				55,23	11000	75,00	11000	91,00	11000

- 1) Ohne Querrillen
- 2) Keine Lagerware, Rückgabe oder Umtausch ausgeschlossen / Lieferzeit 7 Arbeitstage

i Für xxxxx bitte bei der Bestellung den gewünschten Durchmesser angeben (z.B. Ø 6,789 – Bestellnummer 81 015 06789)!

5

145 E / F 25



d ₁ DCONWS mm	d ₁ Zoll	● Querrillen 145 E / F 25		● Glatt 145 E / F 25		● Querrillen 145 E / F 25		■ Querrillen 145 E / F 25	
		NEW Y8 Bestell Nr. 81 015 ... EUR	XXXXX ²⁾	NEW Y8 Bestell Nr. 81 017 ... EUR		NEW Y8 Bestell Nr. 81 027 ... EUR		NEW Y8 Bestell Nr. 81 029 ... EUR	
11,001 - 11,112		90,69	XXXXX ²⁾						
11,113	7/16	90,69	11113	75,00	11113				
11,114 - 11,499		90,69	XXXXX ²⁾						
11,500		55,23	11500	75,00	11500				
11,501 - 11,999		90,69	XXXXX ²⁾						
12,000		55,23	12000	75,00	12000	91,00	12000	91,00	12000
12,001 - 12,499		90,69	XXXXX ²⁾						
12,500		55,23	12500	75,00	12500				
12,501 - 12,699		90,69	XXXXX ²⁾						
12,700	1/2	90,69	12700	75,00	12700	91,00	12700		
12,701 - 12,999		90,69	XXXXX ²⁾						
13,000		55,23	13000	75,00	13000	91,00	13000	91,00	13000
13,001 - 13,499		90,69	XXXXX ²⁾						
13,500		55,23	13500	75,00	13500				
13,501 - 13,999		90,69	XXXXX ²⁾						
14,000		55,23	14000	75,00	14000	91,00	14000	91,00	14000
14,001 - 14,499		90,69	XXXXX ²⁾						
14,500		55,23	14500	75,00	14500				
14,501 - 14,999		90,69	XXXXX ²⁾						
15,000		55,23	15000	75,00	15000	91,00	15000	163,00	15000
15,001 - 15,499		90,69	XXXXX ²⁾						
15,500		55,23	15500	75,00	15500				
15,501 - 15,999		90,69	XXXXX ²⁾						
16,000		55,23	16000	75,00	16000	91,00	16000		
16,001 - 16,499		90,69	XXXXX ²⁾						
16,500		55,23	16500	75,00	16500				
16,501 - 16,999		90,69	XXXXX ²⁾						
17,000		55,23	17000	75,00	17000	91,00	17000		
17,001 - 17,499		90,69	XXXXX ²⁾						
17,500		55,23	17500	75,00	17500				
17,501 - 17,999		90,69	XXXXX ²⁾						
18,000		55,23	18000	75,00	18000	198,70	18000		
18,001 - 18,499		90,69	XXXXX ²⁾						
18,500		55,23	18500	75,00	18500				
18,501 - 18,999		90,69	XXXXX ²⁾						
19,000		55,23	19000	75,00	19000	198,70	19000		
19,001 - 19,049		90,69	XXXXX ²⁾						
19,050	3/4	90,69	19050						
19,051 - 19,499		90,69	XXXXX ²⁾						
19,500		55,23	19500	75,00	19500				
19,501 - 19,999		90,69	XXXXX ²⁾						
20,000		55,23	20000	75,00	20000				

- 1) Ohne Querrillen
- 2) Keine Lagerware, Rückgabe oder Umtausch ausgeschlossen / Lieferzeit 7 Arbeitstage

i Für xxxxx bitte bei der Bestellung den gewünschten Durchmesser angeben (z.B. Ø 6,789 – Bestellnummer 81 015 06789)!

Druckspannzangen

Bezeichnung	d DGUI mm	D DFC mm	A DCLC mm	I LCLC mm	L ₁ OAL mm	K°
F 37 / 1536 E	37	47	40	10	92	16

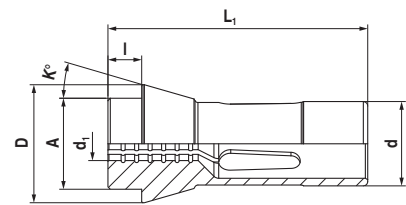

F 37 / 1536 E



d ₁ DCONWS mm	d ₁ Zoll	● Querrillen F 37 / 1536 E		● Glatt F 37 / 1536 E		◻ Querrillen F 37 / 1536 E		◻ Querrillen F 37 / 1536 E	
		NEW Y8 Bestell Nr. 81 023 ... EUR		NEW Y8 Bestell Nr. 81 025 ... EUR		NEW Y8 Bestell Nr. 81 028 ... EUR		NEW Y8 Bestell Nr. 81 030 ... EUR	
1,000				107,00	01000				
1,001 - 1,499				113,10	xxxxx ²⁾				
1,500				107,00	01500				
1,501 - 1,999				113,10	xxxxx ²⁾				
2,000				107,00	02000				
2,001 - 2,499				113,10	xxxxx ²⁾				
2,500				107,00	02500				
2,501 - 2,999				113,10	xxxxx ²⁾				
3,000				77,55	03000	248,60	03000 ¹⁾	198,70	03000 ¹⁾
3,001 - 3,499				113,10	xxxxx ²⁾				
3,500				77,55	03500				
3,501 - 3,999				113,10	xxxxx ²⁾				
4,000				77,55	04000	127,40	04000 ¹⁾	198,70	04000 ¹⁾
4,001 - 4,499				113,10	xxxxx ²⁾				
4,500				77,55	04500				
4,501 - 4,999				113,10	xxxxx ²⁾				
5,000				77,55	05000	127,40	05000 ¹⁾	198,70	05000 ¹⁾
5,001 - 5,499				113,10	xxxxx ²⁾				
5,500				77,55	05500				
5,501 - 5,999				113,10	xxxxx ²⁾				
6,000				77,55	06000	127,40	06000 ¹⁾	198,70	06000 ¹⁾
6,001 - 6,349				113,10	xxxxx ²⁾				
6,350	1/4			113,10	06350	97,31	06350	168,10	06350 ¹⁾
6,351 - 6,499				113,10	xxxxx ²⁾				
6,500				77,55	06500	97,31	06500		
6,501 - 6,999				113,10	xxxxx ²⁾				
7,000				77,55	07000	97,31	07000	127,40	07000 ¹⁾
7,001 - 7,499				113,10	xxxxx ²⁾			198,70	07000 ¹⁾
7,500				77,55	07500	97,31	07500		
7,501 - 7,999				113,10	xxxxx ²⁾				
8,000				77,55	08000	97,31	08000	127,40	08000
8,001 - 8,499				113,10	xxxxx ²⁾			198,70	08000
8,500				77,55	08500	97,31	08500		
8,501 - 8,999				113,10	xxxxx ²⁾				
9,000				77,55	09000	97,31	09000	127,40	09000
9,001 - 9,499				113,10	xxxxx ²⁾			198,70	09000
9,500				77,55	09500	97,31	09500		
9,501 - 9,524				113,10	xxxxx ²⁾				
9,525	3/8			113,10	09525				
9,526 - 9,999				113,10	xxxxx ²⁾				
10,000				77,55	10000	97,31	10000	127,40	10000
10,001 - 10,499				113,10	xxxxx ²⁾			198,70	10000
10,500				77,55	10500	97,31	10500		

1) Ohne Querrillen
2) Keine Lagerware, Rückgabe oder Umtausch ausgeschlossen / Lieferzeit 7 Arbeitstage

i Für xxxxx bitte bei der Bestellung den gewünschten Durchmesser angeben (z.B. Ø 6,789 – Bestellnummer 81 023 06789)!

F 37 / 1536 E



d ₁ DCONWS mm	d ₁ Zoll	● Querrillen F 37 / 1536 E		● Glatt F 37 / 1536 E		⬡ Querrillen F 37 / 1536 E		■ Querrillen F 37 / 1536 E	
		NEW Y8 Bestell Nr. 81 023 ... EUR	XXXXX ²⁾	NEW Y8 Bestell Nr. 81 025 ... EUR		NEW Y8 Bestell Nr. 81 028 ... EUR		NEW Y8 Bestell Nr. 81 030 ... EUR	
10,501 - 10,999		113,10	XXXXX ²⁾						
11,000		77,55	11000	97,31	11000	127,40	11000	198,70	11000
11,001 - 11,499		113,10	XXXXX ²⁾						
11,500		77,55	11500	97,31	11500				
11,501 - 11,999		113,10	XXXXX ²⁾						
12,000		77,55	12000	97,31	12000	127,40	12000	198,70	12000
12,001 - 12,499		113,10	XXXXX ²⁾						
12,500		77,55	12500	97,31	12500				
12,501 - 12,699		113,10	XXXXX ²⁾						
12,700	1/2	113,10	12700	97,31	12700	168,10	12700	198,70	12700
12,701 - 12,999		113,10	XXXXX ²⁾						
13,000		77,55	13000	97,31	13000	127,40	13000	198,70	13000
13,001 - 13,499		113,10	XXXXX ²⁾						
13,500		77,55	13500	97,31	13500				
13,501 - 13,999		113,10	XXXXX ²⁾						
14,000		77,55	14000	97,31	14000	127,40	14000	198,70	14000
14,001 - 14,499		113,10	XXXXX ²⁾						
14,500		77,55	14500	97,31	14500				
14,501 - 14,999		113,10	XXXXX ²⁾						
15,000		77,55	15000	97,31	15000	127,40	15000	198,70	15000
15,001 - 15,499		113,10	XXXXX ²⁾						
15,500		77,55	15500	97,31	15500				
15,501 - 15,999		113,10	XXXXX ²⁾						
16,000		77,55	16000	97,31	16000	127,40	16000	198,70	16000
16,001 - 16,499		113,10	XXXXX ²⁾						
16,500		77,55	16500	97,31	16500				
16,501 - 16,999		113,10	XXXXX ²⁾						
17,000		77,55	17000	97,31	17000	127,40	17000	198,70	17000
17,001 - 17,499		113,10	XXXXX ²⁾						
17,500		77,55	17500	97,31	17500				
17,501 - 17,999		113,10	XXXXX ²⁾						
18,000		77,55	18000	97,31	18000	127,40	18000	198,70	18000
18,001 - 18,499		113,10	XXXXX ²⁾						
18,500		77,55	18500	97,31	18500				
18,501 - 18,999		113,10	XXXXX ²⁾						
19,000		77,55	19000	97,31	19000	127,40	19000	198,70	19000
19,001 - 19,049		113,10	XXXXX ²⁾						
19,050	3/4	113,10	19050	97,31	19050				
19,051 - 19,499		113,10	XXXXX ²⁾						
19,500		77,55	19500	97,31	19500				
19,501 - 19,999		113,10	XXXXX ²⁾						
20,000		77,55	20000	97,31	20000	127,40	20000	198,70	20000
20,001 - 20,499		113,10	XXXXX ²⁾						
20,500		77,55	20500	97,31	20500				
20,501 - 20,999		113,10	XXXXX ²⁾						
21,000		77,55	21000	97,31	21000	127,40	21000	198,70	21000
21,001 - 21,499		113,10	XXXXX ²⁾						
21,500		77,55	21500	97,31	21500				
21,501 - 21,999		113,10	XXXXX ²⁾						
22,000		77,55	22000	97,31	22000	127,40	22000	198,70	22000
22,001 - 22,224		113,10	XXXXX ²⁾						
22,225	7/8	113,10	22225						
22,226 - 22,499		113,10	XXXXX ²⁾						

1) Ohne Querrillen

2) Keine Lagerware, Rückgabe oder Umtausch ausgeschlossen / Lieferzeit 7 Arbeitstage

i Für xxxxx bitte bei der Bestellung den gewünschten Durchmesser angeben (z.B. Ø 6,789 – Bestellnummer 81 023 06789)!

F 37 / 1536 E



d ₁ DCONWS mm	d ₁ Zoll	● Querrillen F 37 / 1536 E		● Glatt F 37 / 1536 E		◈ Querrillen F 37 / 1536 E		■ Querrillen F 37 / 1536 E	
		NEW Y8 Bestell Nr. 81 023 ... EUR	22500	NEW Y8 Bestell Nr. 81 025 ... EUR	22500	NEW Y8 Bestell Nr. 81 028 ... EUR	23000	NEW Y8 Bestell Nr. 81 030 ... EUR	23000
22,500		97,31	22500	77,55	22500				
22,501 - 22,999		113,10	xxxxx ²⁾						
23,000		97,31	23000	77,55	23000	127,40	23000	198,70	23000
23,001 - 23,499		113,10	xxxxx ²⁾						
23,500		97,31	23500	77,55	23500				
23,501 - 23,999		113,10	xxxxx ²⁾						
24,000		97,31	24000	77,55	24000	127,40	24000		
24,001 - 24,499		113,10	xxxxx ²⁾						
24,500		97,31	24500	77,55	24500				
24,501 - 24,999		113,10	xxxxx ²⁾						
25,000		77,55	25000	97,31	25000	127,40	25000		
25,001 - 25,499		113,10	xxxxx ²⁾						
25,400	1/1					168,10	25400		
25,500		77,55	25500	97,31	25500				
25,501 - 25,999		113,10	xxxxx ²⁾						
26,000		77,55	26000	97,31	26000	127,40	26000		
26,001 - 26,499		113,10	xxxxx ²⁾						
26,500		77,55	26500	97,31	26500				
26,501 - 26,999		113,10	xxxxx ²⁾						
27,000		77,55	27000	97,31	27000	127,40	27000		
27,001 - 27,499		113,10	xxxxx ²⁾						
27,500		77,55	27500	97,31	27500				
27,501 - 27,999		113,10	xxxxx ²⁾						
28,000		77,55	28000	97,31	28000				
28,001 - 28,499		113,10	xxxxx ²⁾						
28,500		77,55	28500	97,31	28500				
28,501 - 28,999		113,10	xxxxx ²⁾						
29,000		77,55	29000	97,31	29000				
29,001 - 29,499		113,10	xxxxx ²⁾						
29,500		77,55	29500	97,31	29500				
29,501 - 29,999		113,10	xxxxx ²⁾						
30,000		77,55	30000	97,31	30000				
30,001 - 30,499		113,10	xxxxx ²⁾						
30,500		77,55	30500	97,31	30500				
30,501 - 30,999		113,10	xxxxx ²⁾						
31,000		77,55	31000	97,31	31000				
31,001 - 31,499		113,10	xxxxx ²⁾						
31,500		77,55	31500	97,31	31500				
31,501 - 31,999		113,10	xxxxx ²⁾						
32,000		77,55	32000	97,31	32000				

- 1) Ohne Querrillen
- 2) Keine Lagerware, Rückgabe oder Umtausch ausgeschlossen / Lieferzeit 7 Arbeitstage

i Für xxxxx bitte bei der Bestellung den gewünschten Durchmesser angeben (z.B. Ø 6,789 – Bestellnummer 81 023 06789)!

Highlights

- Präzision „Made in Germany“
verlässliche Qualität
- in 1/100 Abstufungen erhältlich
höchste Flexibilität
- in glatter Ausführung
keine Abdrücke auf dem Werkstück
- alle relevanten Flächen sind
„präzisionsgeschliffen“
erhöht die Bauteilgenauigkeit
- angepasster Vorbau
maximale Stabilität bei
geringster Kollisionsgefahr

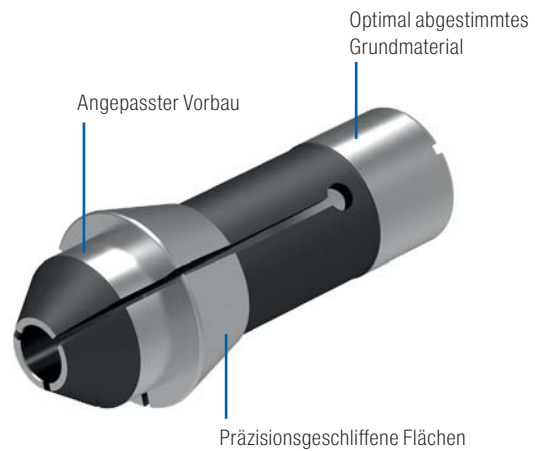

Übersicht Vorbauspannzangen

Norm	Bereich Klemmdurchmesser in mm	Profil	Ausführung	Seite
116E	Ø 1,0 – 8,0	●	Glatt	13
120E	Ø 1,0 – 8,0	●	Glatt	13
F16	Ø 1,0 – 9,0	●	Glatt	13
138E	Ø 1,0 – 12,0	●	Glatt	13
136E	Ø 1,0 – 14,0	●	Glatt	14
145E	Ø 1,0 – 20,0	●	Glatt	14
F37	Ø 1,0 – 28,0	●	Glatt	14

Vorbauspannzangen

Bezeichnung	d DGUI mm	D DFC mm	A DCLC mm	I LCLC mm	L ₁ OAL mm	K°	I ₁ LFSF mm
116 E / F 13	13	19	13	12	70	16	6
120 E / F 15	15	21	15	13	71	16	7
120 E / F 15	15	21	15	15	73	16	9
F 16 / 1212 E	16	21	16	13	71	16	7
F 16 / 1212 E	16	21	16	15	73	16	9
138 E / F20-87	20	28	21	15	78	16	8
138 E / F20-87	20	28	21	20	80	16	13

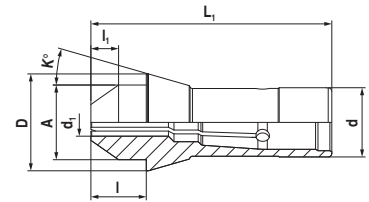

116 E / F 13



Glatt

116 E / F 13

NEW Y8

Bestell Nr.

81 001 ...

EUR

d ₁ DCONWS mm	EUR	...
1	234,40	01000
2	234,40	02000
3	213,00	03000
4	213,00	04000
5	213,00	05000
6	213,00	06000
7	213,00	07000

F 16 / 1212 E



Glatt

F 16 / 1212 E

I₁ = 7 mm

NEW Y8

Bestell Nr.

81 020 ...

EUR

d ₁ DCONWS mm	EUR	...
1	235,40	01000
2	235,40	02000
3	216,00	03000
4	216,00	04000
5	216,00	05000
6	216,00	06000
7	216,00	07000
8	216,00	08000
9	216,00	09000

Glatt

F 16 / 1212 E

I₁ = 9 mm

NEW Y8

Bestell Nr.

81 022 ...

EUR

120 E / F 15



Glatt

120 E / F 15

I₁ = 7 mm

NEW Y8

Bestell Nr.

81 004 ...

EUR

d ₁ DCONWS mm	EUR	...
1	235,40	01000
2	235,40	02000
3	216,00	03000
4	216,00	04000
5	216,00	05000
6	216,00	06000
7	216,00	07000
8	216,00	08000

Glatt

120 E / F 15

I₁ = 9 mm

NEW Y8

Bestell Nr.

81 006 ...

EUR

138 E / F20-87



Glatt

138 E / F20-87

I₁ = 8 mm

NEW Y8

Bestell Nr.

81 012 ...

EUR

d ₁ DCONWS mm	EUR	...
1	282,30	01000
2	282,30	02000
3	262,90	03000
4	262,90	04000
5	262,90	05000
6	262,90	06000
7	262,90	07000
8	262,90	08000
9	262,90	09000
10	262,90	10000
11	262,90	11000
12	262,90	12000

Glatt

138 E / F20-87

I₁ = 13 mm

NEW Y8

Bestell Nr.

81 014 ...

EUR

Vorbauspannzangen

Bezeichnung	d DGUI mm	D DFC mm	A DCLC mm	I LCLC mm	L ₁ OAL mm	K°	I ₁ LFSF mm
136 E / F 20-201	20	26	19	13	62	15	8
136 E / F 20-201	20	26	19	15	64	15	10
145 E / F 25	25	35	27	20	87	16	10
145 E / F 25	25	35	27	25	92	16	15
F 37 / 1536 E	37	47	40	25	107	16	15

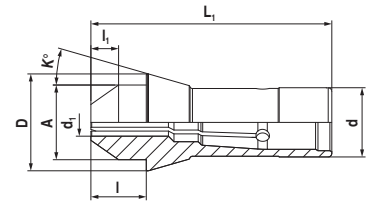

136 E / F 20-201

F 37 / 1536 E



d ₁ DCONWS mm	Glatt 136 E / F 20-201 I ₁ = 8 mm		Glatt 136 E / F 20-201 I ₁ = 10 mm	
	NEW Y8 Bestell Nr. 81 008 ...	EUR	NEW Y8 Bestell Nr. 81 010 ...	EUR
1	282,30	01000	282,30	01000
2	282,30	02000	282,30	02000
3	262,90	03000	262,90	03000
4	262,90	04000	262,90	04000
5	262,90	05000	262,90	05000
6	282,30	06000	262,90	06000
7	282,30	07000	262,90	07000
8	262,90	08000	262,90	08000
9	262,90	09000	262,90	09000
10	262,90	10000	262,90	10000
11	262,90	11000	262,90	11000
12	262,90	12000	262,90	12000
13			262,90	13000
14			262,90	14000

d ₁ DCONWS mm	Glatt F 37 / 1536 E	
	NEW Y8 Bestell Nr. 81 024 ...	EUR
1	315,90	01000
2	315,90	02000
3	270,00	03000
4	270,00	04000
5	270,00	05000
6	270,00	06000
7	270,00	07000
8	270,00	08000
9	270,00	09000
10	270,00	10000
11	270,00	11000
12	270,00	12000
13	302,60	13000
14	270,00	14000
15	270,00	15000
16	270,00	16000
17	270,00	17000
18	270,00	18000
19	270,00	19000
20	270,00	20000
21	270,00	21000
22	270,00	22000
23	270,00	23000
24	270,00	24000
25	270,00	25000
26	270,00	26000
27	270,00	27000
28	270,00	28000

145 E / F 25



d ₁ DCONWS mm	Glatt 145 E / F 25 I ₁ = 10 mm		Glatt 145 E / F 25 I ₁ = 15 mm	
	NEW Y8 Bestell Nr. 81 016 ...	EUR	NEW Y8 Bestell Nr. 81 018 ...	EUR
1	282,30	01000	282,30	01000
2	282,30	02000	282,30	02000
3	262,90	03000	262,90	03000
4	262,90	04000	262,90	04000
5	262,90	05000	262,90	05000
6	262,90	06000	262,90	06000
7	262,90	07000	262,90	07000
8	262,90	08000	262,90	08000
9	262,90	09000	262,90	09000
10	262,90	10000	262,90	10000
11	262,90	11000	262,90	11000
12	262,90	12000	262,90	12000
13	262,90	13000	262,90	13000
14	262,90	14000	262,90	14000
15	262,90	15000	262,90	15000
16	262,90	16000	262,90	16000
17	262,90	17000	262,90	17000
18	262,90	18000	262,90	18000
19	262,90	19000	262,90	19000
20	262,90	20000	262,90	20000

Highlights

- Präzision „Made in Germany“
verlässliche Qualität
- Standardnorm mit Hartmetall-Inlett
höhere Lebensdauer
- in Rund, Vierkant oder Sechskant
Anpassung auf das Material
- alle relevanten Flächen sind
„präzisionsgeschliffen“
erhöht die Bauteilgenauigkeit
- optimal auf Stangenwerkstoff
einstellbar
garantiert höchste Bauteilgenauigkeiten

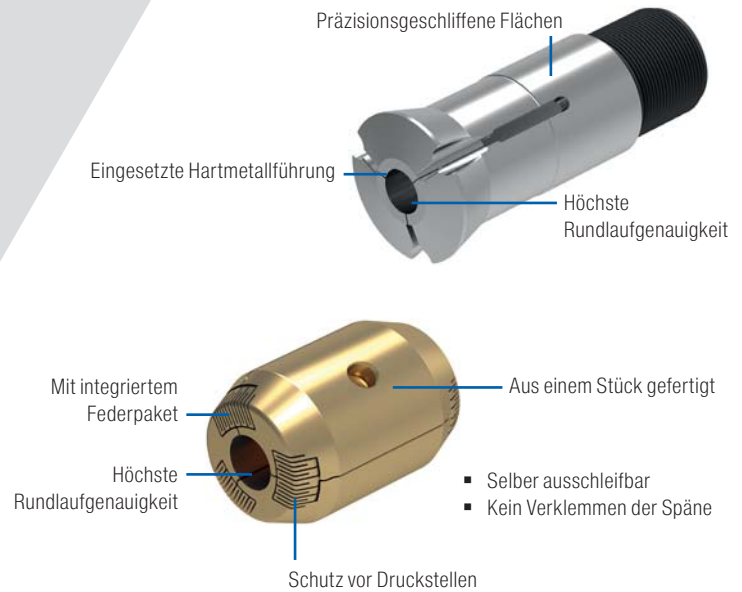

Übersicht verstellbare Führungsbuchsen

Norm	Bereich Führungsdurchmesser in mm	Profil	Ausführung	Seite
I353	Ø 1,0 - 10,5	○	Hartmetalleinsatz	16
F853	Ø 1,0 - 13,0	○	Hartmetalleinsatz	17
F391	Ø 1,0 - 18,0	○	Hartmetalleinsatz	18
F605	Ø 1,0 - 17,0	○	Hartmetalleinsatz	19
T223	Ø 1,0 - 22,0	○	Hartmetalleinsatz	20
I357	Ø 2,0 - 22,0	○	Hartmetalleinsatz	21
T227	Ø 1,0 - 25,0	○	Hartmetalleinsatz	22
T229	Ø 2,0 - 32,0	○	Hartmetalleinsatz	23
T223	SW 2,0 - 11,0	⬡	Hartmetalleinsatz	20
T229	SW 2,0 - 14,0	⬡	Hartmetalleinsatz	23
T223	SW 2,0 - 15,0	■	Hartmetalleinsatz	20

Übersicht flexible Führungsbuchsen GBE

GBE 28	Ø 2,0 - 15,0	○	24
GBE 42	Ø 2,0 - 15,0	○	24

verstellbare Führungsbuchsen

Bezeichnung	d DGUI mm	D DFC mm	L ₁ OAL mm	K°	G THOD
I 353	16	19,5	59	16	M14 x 1

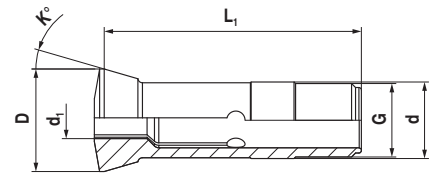

I 353

- für star*-CNC-Langdrehautomaten
- mit Hartmetalleinsatz



I 353

NEW Y8

Bestell Nr.
81 035 ...

EUR

d ₁ DCONWS mm	EUR	
1,0	138,60	01000
1,5	127,40	01500
2,0	127,40	02000
2,5	127,40	02500
3,0	127,40	03000
3,5	127,40	03500
4,0	127,40	04000
4,5	101,90	04500
5,0	101,90	05000
5,5	113,10	05500
6,0	113,10	06000
6,5	120,20	06500
7,0	120,20	07000
7,5	127,40	07500
8,0	127,40	08000
8,5	131,50	08500
9,0	131,50	09000
9,5	136,60	09500
10,0	136,60	10000
10,5	141,60	10500

verstellbare Führungsbuchsen

Bezeichnung	d DGUI mm	D DFC mm	L ₁ OAL mm	K°	G THOD
F 853	18	22	60	30	M16 x 1

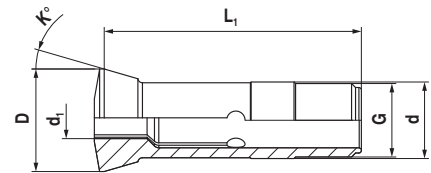

F 853

- mit Hartmetalleinsatz



F 853

d ₁ DCONWS mm	NEW Y8 Bestell Nr. 81 034 ... EUR
1,0	138,60 01000
1,5	127,40 01500
2,0	127,40 02000
2,5	127,40 02500
3,0	127,40 03000
3,5	127,40 03500
4,0	127,40 04000
4,5	101,90 04500
5,0	101,90 05000
5,5	113,10 05500
6,0	113,10 06000
6,5	120,20 06500
7,0	120,20 07000
7,5	127,40 07500
8,0	127,40 08000
8,5	131,50 08500
9,0	131,50 09000
9,5	136,60 09500
10,0	136,60 10000
10,5	141,60 10500
11,0	141,60 11000
11,5	147,80 11500
12,0	147,80 12000
12,5	154,90 12500
13,0	154,90 13000

verstellbare Führungsbuchsen

Bezeichnung	d DGUI mm	D DFC mm	L ₁ OAL mm	K°	G THOD
F 391	22	29	68	16	M22 x 1

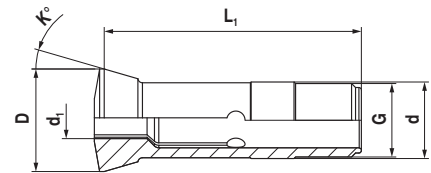

F 391

▪ mit Hartmetalleinsatz



F 391

d ₁ DCONWS mm	d ₁ Zoll	NEW Y8 Bestell Nr. 81 032 ... EUR	
1,000		154,90	01000
1,001 - 1,499		166,10	xxxxx ¹⁾
1,500		130,40	01500
1,501 - 1,999		166,10	xxxxx ¹⁾
2,000		130,40	02000
2,001 - 2,499		166,10	xxxxx ¹⁾
2,500		105,00	02500
2,501 - 2,999		166,10	xxxxx ¹⁾
3,000		105,00	03000
3,001 - 3,499		166,10	xxxxx ¹⁾
3,500		99,76	03500
3,501 - 3,999		166,10	xxxxx ¹⁾
4,000		99,76	04000
4,001 - 4,499		166,10	xxxxx ¹⁾
4,500		106,00	04500
4,501 - 4,999		166,10	xxxxx ¹⁾
5,000		106,00	05000
5,001 - 5,499		166,10	xxxxx ¹⁾
5,500		117,20	05500
5,501 - 5,999		166,10	xxxxx ¹⁾
6,000		117,20	06000
6,001 - 6,349		166,10	xxxxx ¹⁾
6,350	1/4	166,10	06350
6,351 - 6,499		166,10	xxxxx ¹⁾
6,500		121,30	06500
6,501 - 6,999		166,10	xxxxx ¹⁾
7,000		121,30	07000
7,001 - 7,499		166,10	xxxxx ¹⁾
7,500		130,40	07500
7,501 - 7,999		166,10	xxxxx ¹⁾
8,000		130,40	08000
8,001 - 8,499		166,10	xxxxx ¹⁾
8,500		136,60	08500
8,501 - 8,999		166,10	xxxxx ¹⁾
9,000		136,60	09000
9,001 - 9,499		166,10	xxxxx ¹⁾
9,500		141,60	09500
9,501 - 9,999		166,10	xxxxx ¹⁾
10,000		141,60	10000
10,001 - 10,499		166,10	xxxxx ¹⁾
10,500		146,70	10500
10,501 - 10,999		166,10	xxxxx ¹⁾
11,000		146,70	11000
11,001 - 11,499		166,10	xxxxx ¹⁾
11,500		151,80	11500
11,501 - 11,999		166,10	xxxxx ¹⁾
12,000		151,80	12000

d ₁ DCONWS mm	d ₁ Zoll	NEW Y8 Bestell Nr. 81 032 ... EUR	
12,001 - 12,499		166,10	xxxxx ¹⁾
12,500		165,10	12500
12,501 - 12,699		166,10	xxxxx ¹⁾
12,700	1/2	214,00	12700
12,701 - 12,999		214,00	xxxxx ¹⁾
13,000		165,10	13000
13,001 - 13,499		214,00	xxxxx ¹⁾
13,500		169,20	13500
13,501 - 13,999		214,00	xxxxx ¹⁾
14,000		169,20	14000
14,001 - 14,499		214,00	xxxxx ¹⁾
14,500		178,30	14500
14,501 - 14,999		214,00	xxxxx ¹⁾
15,000		178,30	15000
15,001 - 15,499		214,00	xxxxx ¹⁾
15,500		192,60	15500
15,501 - 15,999		214,00	xxxxx ¹⁾
16,000		192,60	16000
16,001 - 16,499		214,00	xxxxx ¹⁾
16,500		200,70	16500
16,501 - 16,999		214,00	xxxxx ¹⁾
17,000		200,70	17000
17,001 - 17,499		214,00	xxxxx ¹⁾
17,500		210,90	17500
17,501 - 17,999		214,00	xxxxx ¹⁾
18,000		210,90	18000

1) Keine Lagerware, Rückgabe oder Umtausch ausgeschlossen / Lieferzeit 7 Arbeitstage

i Für xxxxx bitte bei der Bestellung den gewünschten Durchmesser angeben (z.B. Ø 6,789 – Bestellnummer 81 032 06789)!

verstellbare Führungsbuchsen

Bezeichnung	d DGUI mm	D DFC mm	L ₁ OAL mm	K°	G THOD
F 605	24	29,5	61	30	M24 x 1

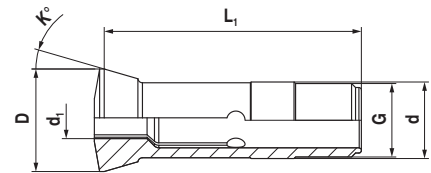

F 605

▪ mit Hartmetalleinsatz



F 605

d ₁ DCONWS mm	d ₁ Zoll	NEW Y8 Bestell Nr. 81 033 ... EUR	
1,000		153,00	01000
1,001 - 1,499		153,90	xxxxx ¹⁾
1,500		130,40	01500
1,501 - 1,999		153,90	xxxxx ¹⁾
2,000		130,40	02000
2,001 - 2,499		153,90	xxxxx ¹⁾
2,500		105,00	02500
2,501 - 2,999		153,90	xxxxx ¹⁾
3,000		105,00	03000
3,001 - 3,174		153,90	xxxxx ¹⁾
3,175	1/8	153,90	03175
3,176 - 3,499		153,90	xxxxx ¹⁾
3,500		99,76	03500
3,501 - 3,999		153,90	xxxxx ¹⁾
4,000		99,76	04000
4,001 - 4,499		153,90	xxxxx ¹⁾
4,500		106,00	04500
4,501 - 4,762		153,90	xxxxx ¹⁾
4,763	3/16	154,90	04763
4,764 - 4,999		154,90	xxxxx ¹⁾
5,000		106,00	05000
5,001 - 5,499		154,90	xxxxx ¹⁾
5,500		117,20	05500
5,501 - 5,999		154,90	xxxxx ¹⁾
6,000		117,20	06000
6,001 - 6,349		154,90	xxxxx ¹⁾
6,350	1/4	166,10	06350
6,351 - 6,499		166,10	xxxxx ¹⁾
6,500		121,30	06500
6,501 - 6,999		166,10	xxxxx ¹⁾
7,000		121,30	07000
7,001 - 7,499		166,10	xxxxx ¹⁾
7,500		130,40	07500
7,501 - 7,999		166,10	xxxxx ¹⁾
8,000		130,40	08000
8,001 - 8,499		166,10	xxxxx ¹⁾
8,500		136,60	08500
8,501 - 8,999		166,10	xxxxx ¹⁾
9,000		136,60	09000
9,001 - 9,499		166,10	xxxxx ¹⁾
9,500		141,60	09500
9,501 - 9,999		166,10	xxxxx ¹⁾
10,000		141,60	10000
10,001 - 10,499		166,10	xxxxx ¹⁾
10,500		146,70	10500
10,501 - 10,999		166,10	xxxxx ¹⁾
11,000		146,70	11000

d ₁ DCONWS mm	d ₁ Zoll	NEW Y8 Bestell Nr. 81 033 ... EUR	
11,001 - 11,499		166,10	xxxxx ¹⁾
11,500		151,80	11500
11,501 - 11,999		166,10	xxxxx ¹⁾
12,000		151,80	12000
12,001 - 12,499		166,10	xxxxx ¹⁾
12,500		165,10	12500
12,501 - 12,699		166,10	xxxxx ¹⁾
12,700	1/2	214,00	12700
12,701 - 12,999		214,00	xxxxx ¹⁾
13,000		165,10	13000
13,001 - 13,499		214,00	xxxxx ¹⁾
13,500		169,20	13500
13,501 - 13,999		214,00	xxxxx ¹⁾
14,000		169,20	14000
14,001 - 14,499		214,00	xxxxx ¹⁾
14,500		178,30	14500
14,501 - 14,999		214,00	xxxxx ¹⁾
15,000		178,30	15000
15,001 - 15,499		214,00	xxxxx ¹⁾
15,500		192,60	15500
15,501 - 15,999		214,00	xxxxx ¹⁾
16,000		192,60	16000
16,001 - 16,499		214,00	xxxxx ¹⁾
16,500		200,70	16500
16,501 - 16,999		214,00	xxxxx ¹⁾
17,000		200,70	17000

1) Keine Lagerware, Rückgabe oder Umtausch ausgeschlossen / Lieferzeit 7 Arbeitstage

i Für xxxxx bitte bei der Bestellung den gewünschten Durchmesser angeben (z.B. Ø 6,789 – Bestellnummer 81 033 06789)!

verstellbare Führungsbuchsen

Bezeichnung	d DGUI mm	D DFC mm	L ₁ OAL mm	K°	G THOD
T 223	28	34	82	16	M25 x 1

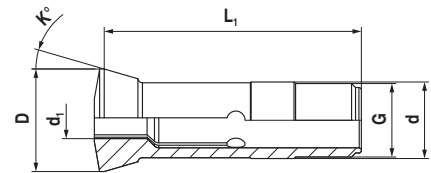

T 223

▪ mit Hartmetalleinsatz



		● T 223		⬡ T 223		■ T 223	
d ₁ DCONWS mm	d ₁ Zoll	NEW Y8 Bestell Nr. 81 037 ... EUR	...	NEW Y8 Bestell Nr. 81 038 ... EUR	...	NEW Y8 Bestell Nr. 81 039 ... EUR	...
1,000		153,00	01000				
1,001 - 1,499		166,10	xxxxx ¹⁾				
1,500		176,30	01500				
1,501 - 1,999		166,10	xxxxx ¹⁾				
2,000		130,40	02000				
2,001 - 2,499		166,10	xxxxx ¹⁾				
2,500		105,00	02500				
2,501 - 2,999		166,10	xxxxx ¹⁾				
3,000		105,00	03000	227,20	03000	339,30	03000
3,001 - 3,499		166,10	xxxxx ¹⁾				
3,500		99,76	03500				
3,501 - 3,999		166,10	xxxxx ¹⁾				
4,000		99,76	04000	222,10	04000	334,20	04000
4,001 - 4,499		166,10	xxxxx ¹⁾				
4,500		106,00	04500				
4,501 - 4,999		166,10	xxxxx ¹⁾				
5,000		106,00	05000	203,80	05000	314,90	05000
5,001 - 5,499		166,10	xxxxx ¹⁾				
5,500		117,20	05500				
5,501 - 5,999		166,10	xxxxx ¹⁾				
6,000		117,20	06000	225,20	06000	337,30	06000
6,001 - 6,349		166,10	xxxxx ¹⁾				
6,350	1/4	166,10	06350	268,80	06350	381,10	06350
6,351 - 6,499		166,10	xxxxx ¹⁾				
6,500		121,30	06500				
6,501 - 6,999		166,10	xxxxx ¹⁾				
7,000		121,30	07000	236,40	07000	348,50	07000
7,001 - 7,499		166,10	xxxxx ¹⁾				
7,500		130,40	07500				
7,501 - 7,999		166,10	xxxxx ¹⁾				
7,938	5/16			283,00	07938		
8,000		130,40	08000	253,70	08000	364,80	08000
8,001 - 8,499		166,10	xxxxx ¹⁾				
8,500		136,60	08500				
8,501 - 8,999		166,10	xxxxx ¹⁾				
9,000		136,60	09000	262,90	09000	375,00	09000
9,001 - 9,499		166,10	xxxxx ¹⁾				
9,500		141,60	09500				
9,501 - 9,999		166,10	xxxxx ¹⁾				
9,525	3/8			308,80	09525		
10,000		141,60	10000	272,10	10000	384,20	10000
10,001 - 10,499		166,10	xxxxx ¹⁾				
10,500		146,70	10500				
10,501 - 10,999		166,10	xxxxx ¹⁾				
11,000		146,70	11000	282,30	11000	394,40	11000
11,001 - 11,499		166,10	xxxxx ¹⁾				
11,500		151,80	11500				

d ₁ DCONWS mm	d ₁ Zoll	NEW Y8 Bestell Nr. 81 037 ... EUR	...	NEW Y8 Bestell Nr. 81 038 ... EUR	...	NEW Y8 Bestell Nr. 81 039 ... EUR	...
11,501 - 11,999		166,10	xxxxx ¹⁾				
12,000		151,80	12000	294,50	12000	405,60	12000
12,001 - 12,499		166,10	xxxxx ¹⁾				
12,500		165,10	12500				
12,501 - 12,699		166,10	xxxxx ¹⁾				
12,700	1/2	214,00	12700	348,50	12700		
12,701 - 12,999		214,00	xxxxx ¹⁾				
13,000		165,10	13000	313,90	13000	425,90	13000
13,001 - 13,499		214,00	xxxxx ¹⁾				
13,500		169,20	13500				
13,501 - 13,999		214,00	xxxxx ¹⁾				
14,000		169,20	14000	322,00	14000	433,10	14000
14,001 - 14,499		214,00	xxxxx ¹⁾				
14,500		178,30	14500				
14,501 - 14,999		214,00	xxxxx ¹⁾				
15,000		178,30	15000	335,30	15000		
15,001 - 15,499		214,00	xxxxx ¹⁾				
15,500		192,60	15500				
15,501 - 15,999		214,00	xxxxx ¹⁾				
16,000		192,60	16000	352,60	16000		
16,001 - 16,499		214,00	xxxxx ¹⁾				
16,500		200,70	16500				
16,501 - 16,999		214,00	xxxxx ¹⁾				
17,000		200,70	17000	365,80	17000		
17,001 - 17,499		214,00	xxxxx ¹⁾				
17,500		210,90	17500				
17,501 - 17,999		214,00	xxxxx ¹⁾				
18,000		210,90	18000				
18,001 - 18,499		214,00	xxxxx ¹⁾				
18,500		220,10	18500				
18,501 - 18,999		214,00	xxxxx ¹⁾				
19,000		220,10	19000				
19,001 - 19,499		214,00	xxxxx ¹⁾				
19,500		224,20	19500				
19,501 - 19,999		214,00	xxxxx ¹⁾				
20,000		224,20	20000				
20,001 - 20,499		214,00	xxxxx ¹⁾				
20,500		237,40	20500				
20,501 - 20,999		214,00	xxxxx ¹⁾				
21,000		237,40	21000				
21,001 - 21,499		214,00	xxxxx ¹⁾				
21,500		246,60	21500				
21,501 - 21,999		214,00	xxxxx ¹⁾				
22,000		339,30	22000				

1) Keine Lagerware, Rückgabe oder Umtausch ausgeschlossen / Lieferzeit 7 Arbeitstage

i Für xxxxx bitte bei der Bestellung den gewünschten Durchmesser angeben (z.B. Ø 6,789 – Bestellnummer 81 037 06789)!

verstellbare Führungsbuchsen

Bezeichnung	d DGUI mm	D DFC mm	L ₁ OAL mm	K°	G THOD
I 357	28	38	81	30	M25 x 1

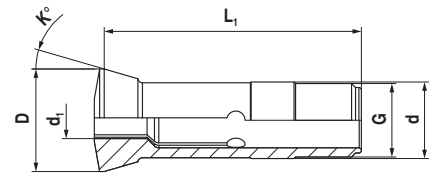

I 357

▪ mit Hartmetalleinsatz



I 357

d ₁ DCONWS mm	d ₁ Zoll	NEW Y8 Bestell Nr. 81 036 ... EUR	
2,000		130,40	02000
2,001 - 2,499		153,90	xxxxx ¹⁾
2,500		130,40	02500
2,501 - 2,999		153,90	xxxxx ¹⁾
3,000		105,00	03000
3,001 - 3,174		153,90	xxxxx ¹⁾
3,175	1/8	153,90	03175
3,176 - 3,499		153,90	xxxxx ¹⁾
3,500		99,76	03500
3,501 - 3,999		153,90	xxxxx ¹⁾
4,000		99,76	04000
4,001 - 4,499		153,90	xxxxx ¹⁾
4,500		106,00	04500
4,501 - 4,999		153,90	xxxxx ¹⁾
5,000		106,00	05000
5,001 - 5,499		153,90	xxxxx ¹⁾
5,500		117,20	05500
5,501 - 5,999		153,90	xxxxx ¹⁾
6,000		117,20	06000
6,001 - 6,499		153,90	xxxxx ¹⁾
6,500		121,30	06500
6,501 - 6,999		153,90	xxxxx ¹⁾
7,000		121,30	07000
7,001 - 7,143		153,90	xxxxx ¹⁾
7,144	9/32	170,20	07144
7,145 - 7,499		170,20	xxxxx ¹⁾
7,500		130,40	07500
7,501 - 7,999		170,20	xxxxx ¹⁾
8,000		130,40	08000
8,001 - 8,499		170,20	xxxxx ¹⁾
8,500		136,60	08500
8,501 - 8,999		170,20	xxxxx ¹⁾
9,000		136,60	09000
9,001 - 9,499		170,20	xxxxx ¹⁾
9,500		141,60	09500
9,501 - 9,999		170,20	xxxxx ¹⁾
10,000		141,60	10000
10,001 - 10,499		170,20	xxxxx ¹⁾
10,500		146,70	10500
10,501 - 10,999		170,20	xxxxx ¹⁾
11,000		146,70	11000
11,001 - 11,499		170,20	xxxxx ¹⁾
11,500		151,80	11500
11,501 - 11,999		170,20	xxxxx ¹⁾
12,000		151,80	12000
12,001 - 12,499		170,20	xxxxx ¹⁾
12,500		165,10	12500

d ₁ DCONWS mm	d ₁ Zoll	NEW Y8 Bestell Nr. 81 036 ... EUR	
12,501 - 12,699		214,00	xxxxx ¹⁾
12,700	1/2	214,00	12700
12,701 - 12,999		214,00	xxxxx ¹⁾
13,000		165,10	13000
13,001 - 13,499		214,00	xxxxx ¹⁾
13,500		169,20	13500
13,501 - 13,999		214,00	xxxxx ¹⁾
14,000		169,20	14000
14,001 - 14,499		214,00	xxxxx ¹⁾
14,500		178,30	14500
14,501 - 14,999		214,00	xxxxx ¹⁾
15,000		178,30	15000
15,001 - 15,499		214,00	xxxxx ¹⁾
15,500		192,60	15500
15,501 - 15,999		214,00	xxxxx ¹⁾
16,000		192,60	16000
16,001 - 16,499		214,00	xxxxx ¹⁾
16,500		200,70	16500
16,501 - 16,999		214,00	xxxxx ¹⁾
17,000		200,70	17000
17,001 - 17,499		214,00	xxxxx ¹⁾
17,500		210,90	17500
17,501 - 17,999		214,00	xxxxx ¹⁾
18,000		210,90	18000
18,001 - 18,499		214,00	xxxxx ¹⁾
18,500		220,10	18500
18,501 - 18,999		214,00	xxxxx ¹⁾
19,000		220,10	19000
19,001 - 19,499		214,00	xxxxx ¹⁾
19,500		224,20	19500
19,501 - 19,999		214,00	xxxxx ¹⁾
20,000		224,20	20000
20,001 - 20,499		214,00	xxxxx ¹⁾
20,500		237,40	20500
20,501 - 20,999		214,00	xxxxx ¹⁾
21,000		237,40	21000
21,001 - 21,499		214,00	xxxxx ¹⁾
21,500		246,60	21500
21,501 - 21,999		214,00	xxxxx ¹⁾
22,000		246,60	22000

1) Keine Lagerware, Rückgabe oder Umtausch ausgeschlossen /
Lieferzeit 7 Arbeitstage

i Für xxxxx bitte bei der Bestellung den gewünschten Durchmesser angeben
(z.B. Ø 6,789 – Bestellnummer 81 036 06789)!

verstellbare Führungsbuchsen

Bezeichnung	d DGUI mm	D DFC mm	L ₁ OAL mm	K°	G THOD
T 227	34	41	87,5	10	M34 x 1

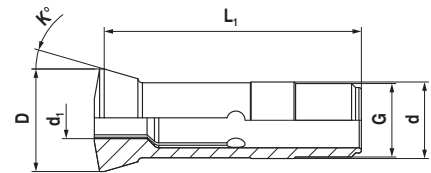

T 227

▪ mit Hartmetalleinsatz



T 227

d ₁ DCONWS mm	d ₁ Zoll	NEW Y8 Bestell Nr. 81 040 ... EUR	
1,000		153,00	01000
1,001 - 1,499		166,10	xxxxx ¹⁾
1,500		153,00	01500
1,501 - 1,999		166,10	xxxxx ¹⁾
2,000		130,40	02000
2,001 - 2,499		166,10	xxxxx ¹⁾
2,500		105,00	02500
2,501 - 2,999		166,10	xxxxx ¹⁾
3,000		105,00	03000
3,001 - 3,499		166,10	xxxxx ¹⁾
3,500		99,76	03500
3,501 - 3,999		166,10	xxxxx ¹⁾
4,000		99,76	04000
4,001 - 4,499		166,10	xxxxx ¹⁾
4,500		106,00	04500
4,501 - 4,999		166,10	xxxxx ¹⁾
5,000		106,00	05000
5,001 - 5,499		166,10	xxxxx ¹⁾
5,500		117,20	05500
5,501 - 5,999		166,10	xxxxx ¹⁾
6,000		117,20	06000
6,001 - 6,349		166,10	xxxxx ¹⁾
6,350	1/4	166,10	06350
6,351 - 6,499		166,10	xxxxx ¹⁾
6,500		121,30	06500
6,501 - 6,999		166,10	xxxxx ¹⁾
7,000		121,30	07000
7,001 - 7,499		166,10	xxxxx ¹⁾
7,500		130,40	07500
7,501 - 7,999		166,10	xxxxx ¹⁾
8,000		130,40	08000
8,001 - 8,499		166,10	xxxxx ¹⁾
8,500		136,60	08500
8,501 - 8,999		166,10	xxxxx ¹⁾
9,000		136,60	09000
9,001 - 9,499		166,10	xxxxx ¹⁾
9,500		141,60	09500
9,501 - 9,999		166,10	xxxxx ¹⁾
10,000		141,60	10000
10,001 - 10,499		166,10	xxxxx ¹⁾
10,500		146,70	10500
10,501 - 10,999		166,10	xxxxx ¹⁾
11,000		146,70	11000
11,001 - 11,499		166,10	xxxxx ¹⁾
11,500		151,80	11500
11,501 - 11,999		166,10	xxxxx ¹⁾
12,000		151,80	12000
12,001 - 12,499		166,10	xxxxx ¹⁾
12,500		165,10	12500

d ₁ DCONWS mm	d ₁ Zoll	NEW Y8 Bestell Nr. 81 040 ... EUR	
12,501 - 12,699		166,10	xxxxx ¹⁾
12,700	1/2	214,00	12700
12,701 - 12,999		214,00	xxxxx ¹⁾
13,000		165,10	13000
13,001 - 13,499		214,00	xxxxx ¹⁾
13,500		169,20	13500
13,501 - 13,999		214,00	xxxxx ¹⁾
14,000		169,20	14000
14,001 - 14,499		214,00	xxxxx ¹⁾
14,500		178,30	14500
14,501 - 14,999		214,00	xxxxx ¹⁾
15,000		178,30	15000
15,001 - 15,499		214,00	xxxxx ¹⁾
15,500		192,60	15500
15,501 - 15,999		214,00	xxxxx ¹⁾
16,000		192,60	16000
16,001 - 16,499		214,00	xxxxx ¹⁾
16,500		200,70	16500
16,501 - 16,999		214,00	xxxxx ¹⁾
17,000		200,70	17000
17,001 - 17,499		214,00	xxxxx ¹⁾
17,500		210,90	17500
17,501 - 17,999		214,00	xxxxx ¹⁾
18,000		210,90	18000
18,001 - 18,499		214,00	xxxxx ¹⁾
18,500		220,10	18500
18,501 - 18,999		214,00	xxxxx ¹⁾
19,000		220,10	19000
19,001 - 19,499		214,00	xxxxx ¹⁾
19,500		224,20	19500
19,501 - 19,999		214,00	xxxxx ¹⁾
20,000		224,20	20000
20,001 - 20,499		214,00	xxxxx ¹⁾
20,500		237,40	20500
20,501 - 20,999		214,00	xxxxx ¹⁾
21,000		237,40	21000
21,001 - 21,499		214,00	xxxxx ¹⁾
21,500		246,60	21500
21,501 - 21,999		214,00	xxxxx ¹⁾
22,000		246,60	22000
22,001 - 22,499		214,00	xxxxx ¹⁾
22,500		253,70	22500
22,501 - 22,999		214,00	xxxxx ¹⁾
23,000		253,70	23000
23,001 - 23,499		214,00	xxxxx ¹⁾
23,500		261,90	23500
23,501 - 23,999		214,00	xxxxx ¹⁾
24,000		261,90	24000
24,001 - 24,499		214,00	xxxxx ¹⁾
24,500		264,90	24500
24,501 - 24,999		214,00	xxxxx ¹⁾
25,000		264,90	25000

1) Keine Lagerware, Rückgabe oder Umtausch ausgeschlossen / Lieferzeit 7 Arbeitstage

i Für xxxxx bitte bei der Bestellung den gewünschten Durchmesser angeben (z.B. Ø 6,789 – Bestellnummer 81 040 06789)!

verstellbare Führungsbuchsen

Bezeichnung	d DGUI mm	D DFC mm	L ₁ OAL mm	K°	G THOD
T 229	42	49	82	16	M40 x 1

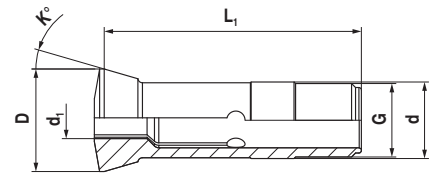

T 229

▪ mit Hartmetalleinsatz



T 229 T 229

d ₁ DCONWS mm	d ₁ Zoll	NEW Y8 Bestell Nr. 81 041 ... EUR	NEW Y8 Bestell Nr. 81 042 ... EUR
2,000		196,50 02000	
2,001 - 2,499		206,90 xxxxx ¹⁾	
2,500		196,50 02500	
2,501 - 2,999		206,90 xxxxx ¹⁾	
3,000		192,60 03000	
3,001 - 3,499		206,90 xxxxx ¹⁾	
3,500		192,60 03500	
3,501 - 3,999		206,90 xxxxx ¹⁾	
4,000		169,20 04000	292,50 04000
4,001 - 4,499		206,90 xxxxx ¹⁾	
4,500		169,20 04500	
4,501 - 4,999		206,90 xxxxx ¹⁾	
5,000		154,90 05000	252,70 05000
5,001 - 5,499		206,90 xxxxx ¹⁾	
5,500		154,90 05500	
5,501 - 5,999		206,90 xxxxx ¹⁾	
6,000		158,00 06000	267,00 06000
6,001 - 6,349		206,90 xxxxx ¹⁾	
6,350		206,90 06350	310,20 06350
6,351 - 6,499	1/4	206,90 xxxxx ¹⁾	
6,500		158,00 06500	
6,501 - 6,999		206,90 xxxxx ¹⁾	
7,000		158,00 07000	273,10 07000
7,001 - 7,499		206,90 xxxxx ¹⁾	
7,500		158,00 07500	
7,501 - 7,999		206,90 xxxxx ¹⁾	
8,000		158,00 08000	281,20 08000
8,001 - 8,499		206,90 xxxxx ¹⁾	
8,500		158,00 08500	
8,501 - 8,999		206,90 xxxxx ¹⁾	
9,000		158,00 09000	285,30 09000
9,001 - 9,499		206,90 xxxxx ¹⁾	
9,500		158,00 09500	
9,501 - 9,524	3/8	206,90 xxxxx ¹⁾	
9,525		206,90 09525	
9,526 - 9,999		206,90 xxxxx ¹⁾	
10,000		158,00 10000	288,40 10000
10,001 - 10,499		206,90 xxxxx ¹⁾	
10,500		158,00 10500	
10,501 - 10,999		206,90 xxxxx ¹⁾	
11,000		163,00 11000	298,60 11000
11,001 - 11,499		206,90 xxxxx ¹⁾	
11,500		163,00 11500	
11,501 - 11,999		206,90 xxxxx ¹⁾	
12,000		163,00 12000	304,70 12000
12,001 - 12,499		206,90 xxxxx ¹⁾	
12,500		163,00 12500	
12,501 - 12,699	1/2	206,90 xxxxx ¹⁾	
12,700		210,90 12700	
12,701 - 12,999		210,90 xxxxx ¹⁾	
13,000		167,10 13000	315,90 13000
13,001 - 13,499		210,90 xxxxx ¹⁾	
13,500		167,10 13500	
13,501 - 13,999		210,90 xxxxx ¹⁾	
14,000		172,20 14000	324,00 14000
14,001 - 14,499		210,90 xxxxx ¹⁾	
14,500		172,20 14500	
14,501 - 14,999		210,90 xxxxx ¹⁾	
15,000		180,40 15000	336,30 15000
15,001 - 15,499		210,90 xxxxx ¹⁾	
15,500		180,40 15500	
15,501 - 15,999		210,90 xxxxx ¹⁾	
16,000		193,60 16000	354,60 16000

d ₁ DCONWS mm	d ₁ Zoll	NEW Y8 Bestell Nr. 81 041 ... EUR	NEW Y8 Bestell Nr. 81 042 ... EUR
16,001 - 16,499		210,90 xxxxx ¹⁾	
16,500		193,60 16500	
16,501 - 16,999		210,90 xxxxx ¹⁾	
17,000		201,80 17000	367,90 17000
17,001 - 17,499		210,90 xxxxx ¹⁾	
17,500		201,80 17500	
17,501 - 17,999		210,90 xxxxx ¹⁾	
18,000		213,00 18000	386,20 18000
18,001 - 18,499		210,90 xxxxx ¹⁾	
18,500		213,00 18500	
18,501 - 18,999		210,90 xxxxx ¹⁾	
19,000		218,10 19000	405,60 19000
19,001 - 19,049		210,90 xxxxx ¹⁾	
19,050	3/4	267,00 19050	
19,051 - 19,499		267,00 xxxxx ¹⁾	
19,500		218,10 19500	
19,501 - 19,999		267,00 xxxxx ¹⁾	
20,000		223,20 20000	417,80 20000
20,001 - 20,499		267,00 xxxxx ¹⁾	
20,500		223,20 20500	
20,501 - 20,999		267,00 xxxxx ¹⁾	
21,000		232,30 21000	437,20 21000
21,001 - 21,499		267,00 xxxxx ¹⁾	
21,500		232,30 21500	
21,501 - 21,999		267,00 xxxxx ¹⁾	
22,000		242,50 22000	453,50 22000
22,001 - 22,224		267,00 xxxxx ¹⁾	
22,225	7/8	291,40 22225	
22,226 - 22,499		291,40 xxxxx ¹⁾	
22,500		242,50 22500	
22,501 - 22,999		291,40 xxxxx ¹⁾	
23,000		253,70 23000	469,80 23000
23,001 - 23,499		291,40 xxxxx ¹⁾	
23,500		253,70 23500	
23,501 - 23,999		291,40 xxxxx ¹⁾	
24,000		258,80 24000	483,00 24000
24,001 - 24,499		291,40 xxxxx ¹⁾	
24,500		258,80 24500	
24,501 - 24,999		291,40 xxxxx ¹⁾	
25,000		262,90 25000	497,30 25000
25,001 - 25,499		291,40 xxxxx ¹⁾	
25,500		262,90 25500	
25,501 - 25,999		291,40 xxxxx ¹⁾	
26,000		269,00 26000	514,60 26000
26,001 - 26,499		291,40 xxxxx ¹⁾	
26,500		269,00 26500	
26,501 - 26,999		291,40 xxxxx ¹⁾	
27,000		283,30 27000	532,90 27000
27,001 - 27,499		291,40 xxxxx ¹⁾	
27,500		283,30 27500	
27,501 - 27,999		291,40 xxxxx ¹⁾	
28,000		299,60 28000	
28,001 - 28,499		291,40 xxxxx ¹⁾	
28,500		299,60 28500	
28,501 - 28,999		291,40 xxxxx ¹⁾	
29,000		313,90 29000	
29,001 - 29,499		291,40 xxxxx ¹⁾	
29,500		313,90 29500	
29,501 - 29,999		291,40 xxxxx ¹⁾	
30,000		322,00 30000	
30,001 - 30,499		291,40 xxxxx ¹⁾	
30,500		322,00 30500	
30,501 - 30,999		291,40 xxxxx ¹⁾	
31,000		333,20 31000	
31,001 - 31,499		291,40 xxxxx ¹⁾	
31,500		333,20 31500	
31,501 - 31,999		291,40 xxxxx ¹⁾	
32,000		343,40 32000	

1) Keine Lagerware, Rückgabe oder Umtausch ausgeschlossen / Lieferzeit 7 Arbeitstage

i Für xxxxx bitte bei der Bestellung den gewünschten Durchmesser angeben (z.B. Ø 6,789 – Bestellnummer 81 041 06789)!

flexible Führungsbuchsen

Bezeichnung	D DFC mm	L ₁ OAL mm	K°
GBE 28	28	40	22,5
GBE 42	42	50	22,5

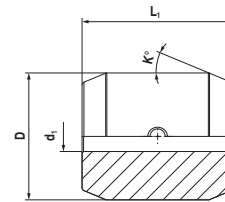

GBE 28



GBE 28

d ₁ DCONWS mm	d ₁ Zoll	NEW Y8 Bestell Nr. 81 059 ... EUR
3,000		404,50 03000
4,000		404,50 04000
5,000		404,50 05000
6,000		404,50 06000
6,350	1/4	404,50 06350
7,000		404,50 07000
8,000		404,50 08000
9,000		404,50 09000
9,525	3/8	404,50 09525
10,000		340,40 10000
11,000		340,40 11000
12,000		340,40 12000
12,700	1/2	340,40 12700
13,000		340,40 13000
14,000		340,40 14000
15,000		340,40 15000
16,000		340,40 16000
17,000		340,40 17000
18,000		340,40 18000
19,000		340,40 19000
19,050	3/4	340,40 19050
20,000		340,40 20000

GBE 42



GBE 42

d ₁ DCONWS mm	d ₁ Zoll	NEW Y8 Bestell Nr. 81 060 ... EUR
3,000		565,60 03000
4,000		565,60 04000
5,000		565,60 05000
6,000		565,60 06000
6,350	1/4	565,60 06350
7,000		565,60 07000
8,000		565,60 08000
9,000		565,60 09000
10,000		565,60 10000
11,000		501,40 11000
12,000		501,40 12000
12,700	1/2	501,40 12700
13,000		501,40 13000
14,000		501,40 14000
15,000		501,40 15000
15,875	5/8	501,40 15880
16,000		501,40 16000
17,000		501,40 17000
18,000		501,40 18000
19,000		501,40 19000
19,050	3/4	501,40 19050
20,000		501,40 20000
21,000		501,40 21000
22,000		501,40 22000
22,225	7/8	501,40 22225
23,000		501,40 23000
24,000		501,40 24000
25,000		501,40 25000
25,400	1/1	501,40 25400
26,000		501,40 26000
27,000		501,40 27000
28,000		501,40 28000
29,000		501,40 29000
30,000		501,40 30000
31,000		501,40 31000
32,000		501,40 32000

Highlights

- Präzision „Made in Germany“
verlässliche Qualität
- als Turbo & Standard erhältlich
höchste Flexibilität
- in rund, vierkant oder sechskant
Anpassung auf das Material
- alle relevanten Flächen sind
„präzisionsgeschliffen“
erhöht die Bauteilgenauigkeit



Übersicht Spannhülsen

Norm	Bereich Außendurchmesser in mm	Bereich Spanndurchmesser	Profil	Ausführung	Seite
S10		Ø 3,0 - 10,0	●		26
S12		Ø 3,0 - 11,0	●		26
S15		Ø 3,0 - 14,0	●		27
S16		Ø 3,0 - 15,0	●		28
S18		Ø 3,0 - 16,0	●		29
S20		Ø 4,0 - 19,0	●		30
S25		Ø 4,0 - 24,0	●		31
ST32 „Turbo“	32	Ø 5,0 - 32,0	●	Turbo	32
S10		SW 3,0 - 8,0	⬡		26
S12		SW 3,0 - 9,0	⬡		26
S15		SW 3,0 - 12,0	⬡		27
S16		SW 3,0 - 13,0	⬡		28
S18		SW 5,0 - 14,0	⬡		29
S20		SW 5,0 - 16,0	⬡		30
S25		SW 5,0 - 20,0	⬡		31
ST32 „Turbo“	32	SW 5,0 - 26,0	⬡	Turbo	32

Spannhülsen

Bezeichnung	Schieber Ø	D DFC mm	Z KWW mm	P _{H7} DCOB mm	L ₁ OAL mm
S 10 / 210 E	D 10	10	4	7	40
S 12 / 212 E	D 12	12	4	8	40

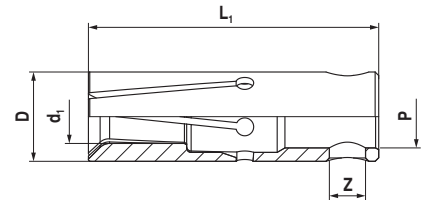

S 10 / 210 E

▪ auch für alle INDEX Mehrspindler geeignet



S 10 / 210 E

S 10 / 210 E

d ₁ DCONWS mm	d ₁ Zoll	NEW Y8	NEW Y8
		Bestell Nr. 81 043 ... EUR	Bestell Nr. 81 044 ... EUR
3,000		43,41 03000	92,63 03000
3,001 - 3,499		47,99 xxxxx ¹⁾	
3,500		43,41 03500	
3,501 - 3,999		47,99 xxxxx ¹⁾	
4,000		29,55 04000	75,81 04000
4,001 - 4,499		47,99 xxxxx ¹⁾	
4,500		29,55 04500	
4,501 - 4,999		47,99 xxxxx ¹⁾	
5,000		29,55 05000	75,81 05000
5,001 - 5,499		47,99 xxxxx ¹⁾	
5,500		29,55 05500	
5,501 - 5,999		47,99 xxxxx ¹⁾	
6,000		29,55 06000	75,81 06000
6,001 - 6,349		47,99 xxxxx ¹⁾	
6,350	1/4	47,99 06350	
6,351 - 6,499		47,99 xxxxx ¹⁾	
6,500		29,55 06500	
6,501 - 6,999		47,99 xxxxx ¹⁾	
7,000		29,55 07000	75,81 07000
7,001 - 7,143		47,99 xxxxx ¹⁾	
7,144	9/32	47,99 07144	
7,145 - 7,499		47,99 xxxxx ¹⁾	
7,500		29,55 07500	
7,501 - 7,937		47,99 xxxxx ¹⁾	
7,938	5/16	47,99 07938	
7,939 - 7,999		47,99 xxxxx ¹⁾	
8,000		29,55 08000	75,81 08000
8,001 - 8,499		47,99 xxxxx ¹⁾	
8,500		29,55 08500	
8,501 - 8,999		47,99 xxxxx ¹⁾	
9,000		43,41 09000	
9,001 - 9,499		47,99 xxxxx ¹⁾	
9,500		43,41 09500	
9,501 - 9,999		47,99 xxxxx ¹⁾	
10,000		43,41 10000	

1) Keine Lagerware, Rückgabe oder Umtausch ausgeschlossen / Lieferzeit 7 Arbeitstage

i Für xxxxx bitte bei der Bestellung den gewünschten Durchmesser angeben (z.B. Ø 6,789 – Bestellnummer 81 043 06789)!

S 12 / 212 E

▪ auch für alle INDEX Mehrspindler geeignet



S 12 / 212 E

S 12 / 212 E

d ₁ DCONWS mm	d ₁ Zoll	NEW Y8	NEW Y8
		Bestell Nr. 81 045 ... EUR	Bestell Nr. 81 046 ... EUR
3,000		44,73 03000	96,60 03000
3,001 - 3,499		49,32 xxxxx ¹⁾	
3,500		44,73 03500	
3,501 - 3,999		49,32 xxxxx ¹⁾	
4,000		30,88 04000	77,44 04000
4,001 - 4,499		49,32 xxxxx ¹⁾	
4,500		30,88 04500	
4,501 - 4,762		49,32 xxxxx ¹⁾	
4,763	3/16	49,32 04763	
4,764 - 4,999		49,32 xxxxx ¹⁾	
5,000		30,88 05000	77,44 05000
5,001 - 5,499		49,32 xxxxx ¹⁾	
5,500		30,88 05500	
5,501 - 5,999		49,32 xxxxx ¹⁾	
6,000		30,88 06000	77,44 06000
6,001 - 6,349		49,32 xxxxx ¹⁾	
6,350	1/4	49,32 06350	102,10 06350
6,351 - 6,499		49,32 xxxxx ¹⁾	
6,500		30,88 06500	
6,501 - 6,999		49,32 xxxxx ¹⁾	
7,000		30,88 07000	77,44 07000
7,001 - 7,499		49,32 xxxxx ¹⁾	
7,500		30,88 07500	
7,501 - 7,937		49,32 xxxxx ¹⁾	
7,938	5/16	49,32 07938	
7,939 - 7,999		49,32 xxxxx ¹⁾	
8,000		30,88 08000	77,44 08000
8,001 - 8,499		49,32 xxxxx ¹⁾	
8,500		30,88 08500	
8,501 - 8,999		49,32 xxxxx ¹⁾	
9,000		30,88 09000	77,44 09000
9,001 - 9,499		49,32 xxxxx ¹⁾	
9,500		30,88 09500	
9,501 - 9,524		49,32 xxxxx ¹⁾	
9,525	3/8	49,32 09525	
9,526 - 9,999		49,32 xxxxx ¹⁾	
10,000		44,73 10000	
10,001 - 10,499		49,32 xxxxx ¹⁾	
10,500		44,73 10500	
10,501 - 10,999		49,32 xxxxx ¹⁾	
11,000		44,73 11000	

1) Keine Lagerware, Rückgabe oder Umtausch ausgeschlossen / Lieferzeit 7 Arbeitstage

i Für xxxxx bitte bei der Bestellung den gewünschten Durchmesser angeben (z.B. Ø 6,789 – Bestellnummer 81 045 06789)!

Spannhülsen

Bezeichnung	Schieber Ø	D DFC mm	Z KWW mm	P _{H7} DCOB mm	L ₁ OAL mm
S 15 / 203 E	D 15	15	6	11	40

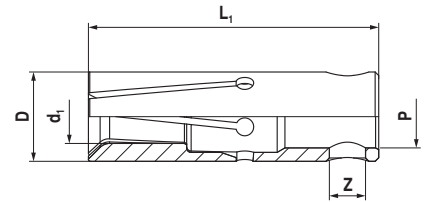

S 15 / 203 E

▪ auch für alle INDEX Mehrspindler geeignet



S 15 / 203 E

S 15 / 203 E

d ₁ DCONWS mm	d ₁ Zoll	NEW Y8		NEW Y8	
		Bestell Nr. 81 047 ... EUR	03000 xxxxx ¹⁾	Bestell Nr. 81 048 ... EUR	03000
3,000		47,99	03000	141,60	03000
3,001 - 3,174		66,44	xxxxx ¹⁾		
3,175	1/8	66,44	03175		
3,176 - 3,499		66,44	xxxxx ¹⁾		
3,500		47,99	03500		
3,501 - 3,999		66,44	xxxxx ¹⁾		
4,000		33,53	04000	80,60	04000
4,001 - 4,499		66,44	xxxxx ¹⁾		
4,500		33,53	04500		
4,501 - 4,999		66,44	xxxxx ¹⁾		
5,000		33,53	05000	80,60	05000
5,001 - 5,499		66,44	xxxxx ¹⁾		
5,500		33,53	05500		
5,501 - 5,999		66,44	xxxxx ¹⁾		
6,000		33,53	06000	80,60	06000
6,001 - 6,349		66,44	xxxxx ¹⁾		
6,350	1/4	51,97	06350	105,30	06350
6,351 - 6,499		51,97	xxxxx ¹⁾		
6,500		33,53	06500		
6,501 - 6,999		51,97	xxxxx ¹⁾		
7,000		33,53	07000	80,60	07000
7,001 - 7,499		51,97	xxxxx ¹⁾		
7,500		33,53	07500		
7,501 - 7,937		51,97	xxxxx ¹⁾		
7,938	5/16	51,97	07938	105,30	07938
7,939 - 7,999		51,97	xxxxx ¹⁾		
8,000		33,53	08000	80,60	08000
8,001 - 8,499		51,97	xxxxx ¹⁾		
8,500		33,53	08500		
8,501 - 8,999		51,97	xxxxx ¹⁾		
9,000		33,53	09000	80,60	09000
9,001 - 9,499		51,97	xxxxx ¹⁾		
9,500		33,53	09500		
9,501 - 9,524		51,97	xxxxx ¹⁾		
9,525	3/8	51,97	09525		
9,526 - 9,999		51,97	xxxxx ¹⁾		
10,000		33,53	10000	80,60	10000
10,001 - 10,499		51,97	xxxxx ¹⁾		
10,500		33,53	10500		
10,501 - 10,999		51,97	xxxxx ¹⁾		
11,000		33,53	11000	116,20	11000
11,001 - 11,112		51,97	xxxxx ¹⁾		
11,113	7/16	51,97	11113		
11,114 - 11,499		51,97	xxxxx ¹⁾		
11,500		33,53	11500		
11,501 - 11,999		51,97	xxxxx ¹⁾		
12,000		33,53	12000	116,20	12000

d ₁ DCONWS mm	d ₁ Zoll	NEW Y8		NEW Y8	
		Bestell Nr. 81 047 ... EUR	xxxxx ¹⁾	Bestell Nr. 81 048 ... EUR	xxxxx ¹⁾
12,001 - 12,499		51,97	xxxxx ¹⁾		
12,500		33,53	12500		
12,501 - 12,699		51,97	xxxxx ¹⁾		
12,700	1/2	51,97	12700		
12,701 - 12,999		51,97	xxxxx ¹⁾		
13,000		33,53	13000		
13,001 - 13,499		51,97	xxxxx ¹⁾		
13,500		48,61	13500		
13,501 - 13,999		51,97	xxxxx ¹⁾		
14,000		48,61	14000		

1) Keine Lagerware, Rückgabe oder Umtausch ausgeschlossen / Lieferzeit 7 Arbeitstage

i Für xxxxx bitte bei der Bestellung den gewünschten Durchmesser angeben (z.B. Ø 6,789 – Bestellnummer 81 047 06789)!

Spannhülsen

Bezeichnung	Schieber Ø	D DFC mm	Z KWW mm	P _{H7} DCOB mm	L ₁ OAL mm
S 16	D 16	16	6	11	40

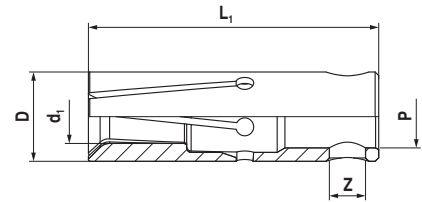

S 16

▪ auch für alle INDEX Mehrspindler geeignet



○ S 16 ⬡ S 16

d ₁ DCONWS mm	d ₁ Zoll	NEW Y8	NEW Y8
		Bestell Nr. 81 049 ... EUR	Bestell Nr. 81 050 ... EUR
3,000		47,99 03000	141,60 03000
3,001 - 3,499		51,97 xxxxx ¹⁾	
3,500		47,99 03500	
3,501 - 3,999		51,97 xxxxx ¹⁾	
4,000		33,53 04000	80,60 04000
4,001 - 4,499		51,97 xxxxx ¹⁾	
4,500		33,53 04500	
4,501 - 4,999		51,97 xxxxx ¹⁾	
5,000		33,53 05000	80,60 05000
5,001 - 5,499		51,97 xxxxx ¹⁾	
5,500		33,53 05500	
5,501 - 5,999		51,97 xxxxx ¹⁾	
6,000		33,53 06000	80,60 06000
6,001 - 6,349		51,97 xxxxx ¹⁾	
6,350	1/4	51,97 06350	
6,351 - 6,499		51,97 xxxxx ¹⁾	
6,500		46,34 06500	
6,501 - 6,999		51,97 xxxxx ¹⁾	
7,000		33,53 07000	80,60 07000
7,001 - 7,499		51,97 xxxxx ¹⁾	
7,500		33,53 07500	
7,501 - 7,999		51,97 xxxxx ¹⁾	
8,000		33,53 08000	80,60 08000
8,001 - 8,499		51,97 xxxxx ¹⁾	
8,500		33,53 08500	
8,501 - 8,999		51,97 xxxxx ¹⁾	
9,000		33,53 09000	80,60 09000
9,001 - 9,499		51,97 xxxxx ¹⁾	
9,500		33,53 09500	
9,501 - 9,524		51,97 xxxxx ¹⁾	
9,525	3/8	51,97 09525	
9,526 - 9,999		51,97 xxxxx ¹⁾	
10,000		33,53 10000	80,60 10000
10,001 - 10,499		51,97 xxxxx ¹⁾	
10,500		33,53 10500	
10,501 - 10,999		51,97 xxxxx ¹⁾	
11,000		33,53 11000	80,60 11000
11,001 - 11,112		51,97 xxxxx ¹⁾	
11,113	7/16	51,97 11113	
11,114 - 11,499		51,97 xxxxx ¹⁾	
11,500		33,53 11500	
11,501 - 11,999		51,97 xxxxx ¹⁾	
12,000		33,53 12000	116,20 12000
12,001 - 12,499		51,97 xxxxx ¹⁾	
12,500		33,53 12500	
12,501 - 12,699		51,97 xxxxx ¹⁾	
12,700	1/2	51,97 12700	

d ₁ DCONWS mm	d ₁ Zoll	NEW Y8	NEW Y8
		Bestell Nr. 81 049 ... EUR	Bestell Nr. 81 050 ... EUR
12,701 - 12,999		51,97 xxxxx ¹⁾	
13,000		33,53 13000	116,20 13000
13,001 - 13,499		51,97 xxxxx ¹⁾	
13,500		48,61 13500	
13,501 - 13,999		51,97 xxxxx ¹⁾	
14,000		48,61 14000	
14,001 - 14,287		51,97 xxxxx ¹⁾	
14,288	9/16	67,05 14288	
14,289 - 14,499		67,05 xxxxx ¹⁾	
14,500		48,61 14500	
14,501 - 14,999		67,05 xxxxx ¹⁾	
15,000		48,61 15000	

1) Keine Lagerware, Rückgabe oder Umtausch ausgeschlossen / Lieferzeit 7 Arbeitstage

i Für xxxxx bitte bei der Bestellung den gewünschten Durchmesser angeben (z.B. Ø 6,789 – Bestellnummer 81 049 06789)!

Spannhülsen

Bezeichnung	Schieber Ø	D DFC mm	Z KWW mm	P _{H7} DCOB mm	L ₁ OAL mm
S 18 / 218 E	D 18	18	6	11	40

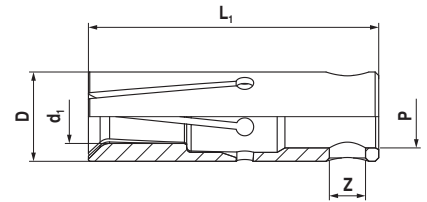

S 18 / 218 E

▪ auch für alle INDEX Mehrspindler geeignet



S 18 / 218 E

S 18 / 218 E

d ₁ DCONWS mm	d ₁ Zoll	NEW Y8		NEW Y8	
		Bestell Nr. 81 051 ... EUR	03000 xxxxx ¹⁾	Bestell Nr. 81 052 ... EUR	05000 xxxxx ¹⁾
3,000		51,97	03000		
3,001 - 3,174		70,31	xxxxx ¹⁾		
3,175	1/8	70,31	03175		
3,176 - 3,499		70,31	xxxxx ¹⁾		
3,500		51,97	03500		
3,501 - 3,999		70,31	xxxxx ¹⁾		
4,000		51,97	04000		
4,001 - 4,499		70,31	xxxxx ¹⁾		
4,500		51,97	04500		
4,501 - 4,762		70,31	xxxxx ¹⁾		
4,763	3/16	70,31	04763		
4,764 - 4,999		70,31	xxxxx ¹⁾		
5,000		36,79	05000	84,58	05000
5,001 - 5,499		70,31	xxxxx ¹⁾		
5,500		36,79	05500		
5,501 - 5,999		70,31	xxxxx ¹⁾		
6,000		36,79	06000	84,58	06000
6,001 - 6,499		70,31	xxxxx ¹⁾		
6,500		36,79	06500		
6,501 - 6,999		70,31	xxxxx ¹⁾		
7,000		36,79	07000	84,58	07000
7,001 - 7,499		70,31	xxxxx ¹⁾		
7,500		36,79	07500		
7,501 - 7,937		70,31	xxxxx ¹⁾		
7,938	5/16	55,23	07938		
7,939 - 7,999		55,23	xxxxx ¹⁾		
8,000		36,79	08000	84,58	08000
8,001 - 8,499		55,23	xxxxx ¹⁾		
8,500		36,79	08500		
8,501 - 8,999		55,23	xxxxx ¹⁾		
9,000		36,79	09000	84,58	09000
9,001 - 9,499		55,23	xxxxx ¹⁾		
9,500		36,79	09500		
9,501 - 9,524		55,23	xxxxx ¹⁾		
9,525	3/8	55,23	09525		
9,526 - 9,999		55,23	xxxxx ¹⁾		
10,000		36,79	10000	84,58	10000
10,001 - 10,499		55,23	xxxxx ¹⁾		
10,500		36,79	10500		
10,501 - 10,999		55,23	xxxxx ¹⁾		
11,000		36,79	11000	120,20	11000
11,001 - 11,112		55,23	xxxxx ¹⁾		
11,113	7/16	55,23	11113		
11,114 - 11,499		55,23	xxxxx ¹⁾		
11,500		36,79	11500		
11,501 - 11,999		55,23	xxxxx ¹⁾		
12,000		36,79	12000	120,20	12000

d ₁ DCONWS mm	d ₁ Zoll	NEW Y8	NEW Y8
		Bestell Nr. 81 051 ... EUR	Bestell Nr. 81 052 ... EUR
12,001 - 12,499		55,23 xxxxx ¹⁾	
12,500		36,79 12500	
12,501 - 12,699		55,23 xxxxx ¹⁾	
12,700	1/2	55,23 12700	141,60 12700
12,701 - 12,999		55,23 xxxxx ¹⁾	
13,000		36,79 13000	120,20 13000
13,001 - 13,499		55,23 xxxxx ¹⁾	
13,500		36,79 13500	
13,501 - 13,999		55,23 xxxxx ¹⁾	
14,000		36,79 14000	120,20 14000
14,001 - 14,287		55,23 xxxxx ¹⁾	
14,288	9/16	55,23 14288	
14,289 - 14,499		55,23 xxxxx ¹⁾	
14,500		36,79 14500	
14,501 - 14,999		55,23 xxxxx ¹⁾	
15,000		36,79 15000	
15,001 - 15,499		55,23 xxxxx ¹⁾	
15,500		36,79 15500	
15,501 - 15,874		55,23 xxxxx ¹⁾	
15,875	5/8	55,23 15875	
15,876 - 15,999		55,23 xxxxx ¹⁾	
16,000		36,79 16000	

1) Keine Lagerware, Rückgabe oder Umtausch ausgeschlossen / Lieferzeit 7 Arbeitstage

i Für xxxxx bitte bei der Bestellung den gewünschten Durchmesser angeben (z.B. Ø 6,789 – Bestellnummer 81 051 06789)!

Spannhülsen

Bezeichnung	Schieber Ø	D DFC mm	Z KWW mm	P _{H7} DCOB mm	L ₁ OAL mm
S 20 / 225 E	D 20	20	8	14	65

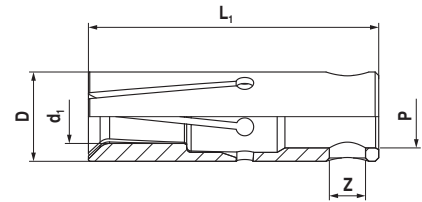

S 20 / 225 E

▪ auch für alle INDEX Mehrspindler geeignet



S 20 / 225 E

S 20 / 225 E

d ₁ DCONWS mm	d ₁ Zoll	NEW Y8	NEW Y8
		Bestell Nr. 81 053 ... EUR	Bestell Nr. 81 054 ... EUR
4,000		51,97	04000
4,001 - 4,499		70,31	xxxxx ¹⁾
4,500		51,97	04500
4,501 - 4,762		70,31	xxxxx ¹⁾
4,763	3/16	70,31	04763
4,764 - 4,999		70,31	xxxxx ¹⁾
5,000		51,97	05000
5,001 - 5,499		70,31	xxxxx ¹⁾
5,500		51,97	05500
5,501 - 5,999		70,31	xxxxx ¹⁾
6,000		38,82	06000
6,001 - 6,349		70,31	xxxxx ¹⁾
6,350	1/4	57,17	06350
6,351 - 6,499		57,17	xxxxx ¹⁾
6,500		38,82	06500
6,501 - 6,999		57,17	xxxxx ¹⁾
7,000		38,82	07000
7,001 - 7,499		57,17	xxxxx ¹⁾
7,500		38,82	07500
7,501 - 7,937		57,17	xxxxx ¹⁾
7,938	5/16	57,17	07938
7,939 - 7,999		57,17	xxxxx ¹⁾
8,000		38,82	08000
8,001 - 8,499		57,17	xxxxx ¹⁾
8,500		38,82	08500
8,501 - 8,999		57,17	xxxxx ¹⁾
9,000		38,82	09000
9,001 - 9,499		57,17	xxxxx ¹⁾
9,500		38,82	09500
9,501 - 9,524		57,17	xxxxx ¹⁾
9,525	3/8	57,17	09525
9,526 - 9,999		57,17	xxxxx ¹⁾
10,000		38,82	10000
10,001 - 10,499		57,17	xxxxx ¹⁾
10,500		38,82	10500
10,501 - 10,999		57,17	xxxxx ¹⁾
11,000		38,82	11000
11,001 - 11,112		57,17	xxxxx ¹⁾
11,113	7/16	57,17	11113
11,114 - 11,499		57,17	xxxxx ¹⁾
11,500		38,82	11500
11,501 - 11,999		57,17	xxxxx ¹⁾
12,000		38,82	12000
12,001 - 12,499		57,17	xxxxx ¹⁾
12,500		38,82	12500
12,501 - 12,699		57,17	xxxxx ¹⁾
12,700	1/2	57,17	12700

d ₁ DCONWS mm	d ₁ Zoll	NEW Y8	NEW Y8
		Bestell Nr. 81 053 ... EUR	Bestell Nr. 81 054 ... EUR
12,701 - 12,999		57,17	xxxxx ¹⁾
13,000		38,82	13000
13,001 - 13,499		57,17	xxxxx ¹⁾
13,500		38,82	13500
13,501 - 13,999		57,17	xxxxx ¹⁾
14,000		38,82	14000
14,001 - 14,499		57,17	xxxxx ¹⁾
14,500		38,82	14500
14,501 - 14,999		57,17	xxxxx ¹⁾
15,000		38,82	15000
15,001 - 15,499		57,17	xxxxx ¹⁾
15,500		38,82	15500
15,501 - 15,999		57,17	xxxxx ¹⁾
16,000		38,82	16000
16,001 - 16,499		57,17	xxxxx ¹⁾
16,500		38,82	16500
16,501 - 16,999		57,17	xxxxx ¹⁾
17,000		38,82	17000
17,001 - 17,499		57,17	xxxxx ¹⁾
17,500		38,82	17500
17,501 - 17,999		57,17	xxxxx ¹⁾
18,000		38,82	18000
18,001 - 18,499		57,17	xxxxx ¹⁾
18,500		51,97	18500
18,501 - 18,999		57,17	xxxxx ¹⁾
19,000		51,97	19000

1) Keine Lagerware, Rückgabe oder Umtausch ausgeschlossen / Lieferzeit 7 Arbeitstage

i Für xxxxx bitte bei der Bestellung den gewünschten Durchmesser angeben (z.B. Ø 6,789 – Bestellnummer 81 053 06789)!

Spannhülsen

Bezeichnung	Schieber Ø	D DFC mm	Z KWW mm	P _{H7} DCOB mm	L ₁ OAL mm
S 25 / 222 E	D 25	25	8	20	65

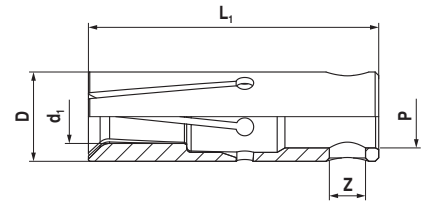

S 25 / 222 E

▪ auch für alle INDEX Mehrspindler geeignet



S 25 / 222 E

S 25 / 222 E

d ₁ DCONWS mm	d ₁ Zoll	NEW Y8	NEW Y8
		Bestell Nr. 81 055 ... EUR	Bestell Nr. 81 056 ... EUR
4,000		53,29 04000	
4,001 - 4,499		58,49 xxxxx ¹⁾	
4,500		53,29 04500	
4,501 - 4,999		58,49 xxxxx ¹⁾	
5,000		53,29 05000	105,00 05000
5,001 - 5,499		58,49 xxxxx ¹⁾	
5,500		53,29 05500	
5,501 - 5,999		58,49 xxxxx ¹⁾	
6,000		40,15 06000	88,65 06000
6,001 - 6,349		58,49 xxxxx ¹⁾	
6,350	1/4	58,49 06350	110,10 06350
6,351 - 6,499		58,49 xxxxx ¹⁾	
6,500		40,15 06500	
6,501 - 6,999		58,49 xxxxx ¹⁾	
7,000		40,15 07000	88,65 07000
7,001 - 7,499		58,49 xxxxx ¹⁾	
7,500		40,15 07500	
7,501 - 7,999		58,49 xxxxx ¹⁾	
8,000		40,15 08000	88,65 08000
8,001 - 8,499		58,49 xxxxx ¹⁾	
8,500		40,15 08500	
8,501 - 8,999		58,49 xxxxx ¹⁾	
9,000		40,15 09000	88,65 09000
9,001 - 9,499		58,49 xxxxx ¹⁾	
9,500		40,15 09500	
9,501 - 9,999		58,49 xxxxx ¹⁾	
10,000		40,15 10000	88,65 10000
10,001 - 10,499		58,49 xxxxx ¹⁾	
10,500		40,15 10500	
10,501 - 10,999		58,49 xxxxx ¹⁾	
11,000		40,15 11000	123,30 11000
11,001 - 11,499		58,49 xxxxx ¹⁾	
11,500		40,15 11500	
11,501 - 11,999		58,49 xxxxx ¹⁾	
12,000		40,15 12000	123,30 12000
12,001 - 12,499		58,49 xxxxx ¹⁾	
12,500		40,15 12500	
12,501 - 12,699		58,49 xxxxx ¹⁾	
12,700	1/2	58,49 12700	
12,701 - 12,999		58,49 xxxxx ¹⁾	
13,000		40,15 13000	123,30 13000
13,001 - 13,499		58,49 xxxxx ¹⁾	
13,500		40,15 13500	
13,501 - 13,999		58,49 xxxxx ¹⁾	
14,000		40,15 14000	123,30 14000
14,001 - 14,499		58,49 xxxxx ¹⁾	
14,500		40,15 14500	

d ₁ DCONWS mm	d ₁ Zoll	NEW Y8	NEW Y8
		Bestell Nr. 81 055 ... EUR	Bestell Nr. 81 056 ... EUR
14,501 - 14,999		58,49 xxxxx ¹⁾	
15,000		40,15 15000	123,30 15000
15,001 - 15,499		58,49 xxxxx ¹⁾	
15,500		40,15 15500	
15,501 - 15,999		58,49 xxxxx ¹⁾	
16,000		40,15 16000	123,30 16000
16,001 - 16,499		58,49 xxxxx ¹⁾	
16,500		40,15 16500	
16,501 - 16,999		58,49 xxxxx ¹⁾	
17,000		40,15 17000	123,30 17000
17,001 - 17,499		58,49 xxxxx ¹⁾	
17,500		40,15 17500	
17,501 - 17,999		58,49 xxxxx ¹⁾	
18,000		40,15 18000	123,30 18000
18,001 - 18,499		58,49 xxxxx ¹⁾	
18,500		40,15 18500	
18,501 - 18,999		58,49 xxxxx ¹⁾	
19,000		40,15 19000	123,30 19000
19,001 - 19,049		58,49 xxxxx ¹⁾	
19,050	3/4	58,49 19050	
19,051 - 19,499		58,49 xxxxx ¹⁾	
19,500		40,15 19500	
19,501 - 19,999		58,49 xxxxx ¹⁾	
20,000		40,15 20000	123,30 20000
20,001 - 20,499		58,49 xxxxx ¹⁾	
20,500		40,15 20500	
20,501 - 20,999		58,49 xxxxx ¹⁾	
21,000		40,15 21000	
21,001 - 21,499		58,49 xxxxx ¹⁾	
21,500		40,15 21500	
21,501 - 21,999		58,49 xxxxx ¹⁾	
22,000		40,15 22000	
22,001 - 22,499		58,49 xxxxx ¹⁾	
22,500		40,15 22500	
22,501 - 22,999		58,49 xxxxx ¹⁾	
23,000		40,15 23000	
23,001 - 23,499		58,49 xxxxx ¹⁾	
23,500		53,29 23500	
23,501 - 23,999		58,49 xxxxx ¹⁾	
24,000		53,29 24000	

1) Keine Lagerware, Rückgabe oder Umtausch ausgeschlossen / Lieferzeit 7 Arbeitstage

i Für xxxxx bitte bei der Bestellung den gewünschten Durchmesser angeben (z.B. Ø 6,789 – Bestellnummer 81 055 06789)!

Spannhülsen - Turbo

Bezeichnung	Schieber Ø	D	P _{H7}	L ₁
		DFC mm	DCOB mm	OAL mm
ST 32	D 32	32	20	90

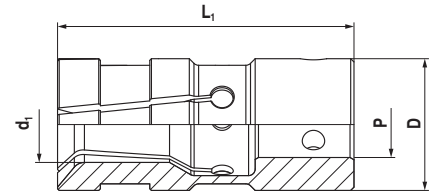

ST 32

▪ auch für alle INDEX Mehrspindler geeignet



ST 32

ST 32

d ₁ DCONWS mm	d ₁ Zoll	NEW Y8		NEW Y8	
		Bestell Nr. 81 057 ... EUR	05000 xxxxx ¹⁾	Bestell Nr. 81 058 ... EUR	05000 xxxxx ¹⁾
5,000		92,02	05000	168,10	05000
5,001 - 5,499		126,40	xxxxx ¹⁾		
5,500		92,02	05500		
5,501 - 5,999		126,40	xxxxx ¹⁾		
6,000		92,02	06000	168,10	06000
6,001 - 6,349		126,40	xxxxx ¹⁾		
6,350	1/4	126,40	06350		
6,351 - 6,499		126,40	xxxxx ¹⁾		
6,500		92,02	06500		
6,501 - 6,999		126,40	xxxxx ¹⁾		
7,000		92,02	07000	168,10	07000
7,001 - 7,499		126,40	xxxxx ¹⁾		
7,500		92,02	07500		
7,501 - 7,999		126,40	xxxxx ¹⁾		
8,000		92,02	08000	168,10	08000
8,001 - 8,499		126,40	xxxxx ¹⁾		
8,500		92,02	08500		
8,501 - 8,999		126,40	xxxxx ¹⁾		
9,000		53,29	09000	120,20	09000
9,001 - 9,499		126,40	xxxxx ¹⁾		
9,500		53,29	09500		
9,501 - 9,524		126,40	xxxxx ¹⁾		
9,525	3/8	87,43	09525		
9,526 - 9,999		87,43	xxxxx ¹⁾		
10,000		53,29	10000	120,20	10000
10,001 - 10,499		87,43	xxxxx ¹⁾		
10,500		53,29	10500		
10,501 - 10,999		87,43	xxxxx ¹⁾		
11,000		53,29	11000	126,40	11000
11,001 - 11,499		87,43	xxxxx ¹⁾		
11,500		53,29	11500		
11,501 - 11,999		87,43	xxxxx ¹⁾		
12,000		53,29	12000	126,40	12000
12,001 - 12,499		87,43	xxxxx ¹⁾		
12,500		53,29	12500		
12,501 - 12,699		87,43	xxxxx ¹⁾		
12,700	1/2	87,43	12700		
12,701 - 12,999		87,43	xxxxx ¹⁾		
13,000		53,29	13000	126,40	13000
13,001 - 13,499		87,43	xxxxx ¹⁾		
13,500		53,29	13500		
13,501 - 13,999		87,43	xxxxx ¹⁾		
14,000		53,29	14000	126,40	14000
14,001 - 14,499		87,43	xxxxx ¹⁾		
14,500		53,29	14500		
14,501 - 14,999		87,43	xxxxx ¹⁾		
15,000		53,29	15000	126,40	15000
15,001 - 15,499		87,43	xxxxx ¹⁾		
15,500		53,29	15500		
15,501 - 15,874		87,43	xxxxx ¹⁾		
15,875	5/8	87,43	15875		
15,876 - 15,999		87,43	xxxxx ¹⁾		
16,000		53,29	16000	126,40	16000
16,001 - 16,499		87,43	xxxxx ¹⁾		
16,500		53,29	16500		
16,501 - 16,999		87,43	xxxxx ¹⁾		
17,000		53,29	17000	126,40	17000

d ₁ DCONWS mm	d ₁ Zoll	NEW Y8		NEW Y8	
		Bestell Nr. 81 057 ... EUR	xxxxx ¹⁾	Bestell Nr. 81 058 ... EUR	xxxxx ¹⁾
17,001 - 17,462		87,43	xxxxx ¹⁾		
17,463	11/16	87,43	17463		
17,464 - 17,499		87,43	xxxxx ¹⁾		
17,500		53,29	17500		
17,501 - 17,999		87,43	xxxxx ¹⁾		
18,000		53,29	18000	126,40	18000
18,001 - 18,499		87,43	xxxxx ¹⁾		
18,500		53,29	18500		
18,501 - 18,999		87,43	xxxxx ¹⁾		
19,000		53,29	19000	126,40	19000
19,001 - 19,049		87,43	xxxxx ¹⁾		
19,050	3/4	87,43	19050		
19,051 - 19,499		87,43	xxxxx ¹⁾		
19,500		53,29	19500		
19,501 - 19,999		87,43	xxxxx ¹⁾		
20,000		53,29	20000	126,40	20000
20,001 - 20,499		87,43	xxxxx ¹⁾		
20,500		53,29	20500		
20,501 - 20,999		87,43	xxxxx ¹⁾		
21,000		53,29	21000	145,70	21000
21,001 - 21,499		87,43	xxxxx ¹⁾		
21,500		53,29	21500		
21,501 - 21,999		87,43	xxxxx ¹⁾		
22,000		53,29	22000	145,70	22000
22,001 - 22,224		87,43	xxxxx ¹⁾		
22,225	7/8	87,43	22225		
22,226 - 22,499		87,43	xxxxx ¹⁾		
22,500		53,29	22500		
22,501 - 22,999		87,43	xxxxx ¹⁾		
23,000		53,29	23000	145,70	23000
23,001 - 23,499		87,43	xxxxx ¹⁾		
23,500		53,29	23500		
23,501 - 23,999		87,43	xxxxx ¹⁾		
24,000		53,29	24000	145,70	24000
24,001 - 24,499		87,43	xxxxx ¹⁾		
24,500		53,29	24500		
24,501 - 24,999		87,43	xxxxx ¹⁾		
25,000		53,29	25000	145,70	25000
25,001 - 25,399		87,43	xxxxx ¹⁾		
25,400	1/1	87,43	25400		
25,401 - 25,499		87,43	xxxxx ¹⁾		
25,500		53,29	25500		
25,501 - 25,999		87,43	xxxxx ¹⁾		
26,000		53,29	26000	145,70	26000
26,001 - 26,499		87,43	xxxxx ¹⁾		
26,500		53,29	26500		
26,501 - 26,999		87,43	xxxxx ¹⁾		
27,000		53,29	27000		
27,001 - 27,499		87,43	xxxxx ¹⁾		
27,500		53,29	27500		
27,501 - 27,999		87,43	xxxxx ¹⁾		
28,000		53,29	28000		
28,001 - 28,499		87,43	xxxxx ¹⁾		
28,500		92,02	28500		
28,501 - 28,574		87,43	xxxxx ¹⁾		
28,575	1 1/8	126,40	28575		
28,576 - 28,999		126,40	xxxxx ¹⁾		
29,000		92,02	29000		
29,001 - 29,499		126,40	xxxxx ¹⁾		
29,500		92,02	29500		
29,501 - 29,999		126,40	xxxxx ¹⁾		
30,000		92,02	30000		

1) Keine Lagerware, Rückgabe oder Umtausch ausgeschlossen / Lieferzeit 7 Arbeitstage

i Für xxxxx bitte bei der Bestellung den gewünschten Durchmesser angeben (z.B. Ø 6,789 – Bestellnummer 81 057 06789)!

Technische Informationen

Rundlaufgenauigkeit

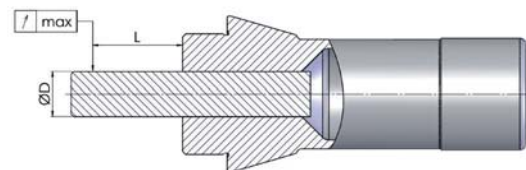
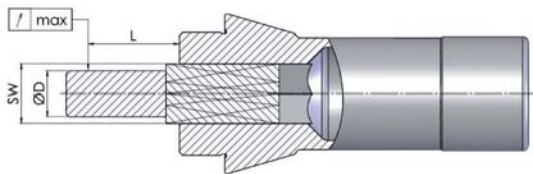

Rundlauftoleranzen von Spannzangen mit Profil					
Profil SW		L mm	Standard Norm	WNT-Norm	
von	bis			Standard	HP*
0,5	0,9	3	0,12	< 0,02	< 0,01
1	1,5	6	0,12	< 0,02	< 0,01
1,6	3	10	0,12	< 0,02	< 0,01
3,1	6	16	0,12	< 0,02	< 0,01
6,1	10	25	0,15	< 0,02	< 0,01
10,1	18	40	0,2	< 0,02	< 0,01
18,1	24	50	0,2	< 0,02	< 0,01
24,1	30	60	0,2	< 0,02	< 0,01
30,0		80	0,2	< 0,02	< 0,01

* Geringere Rundlauftoleranzen mit der WNT HP (HighPrecision)-option auf Anfrage.

Rundlauftoleranzen von runden Spannzangen				
Bohrung		L mm	WNT-Norm	
von	bis		Standard	HP*
0,5	0,9	3	< 0,01	< 0,008
1	1,5	6	< 0,01	< 0,008
1,6	3	10	< 0,015	< 0,008
3,1	6	16	< 0,015	< 0,008
6,1	10	25	< 0,015	< 0,008
10,1	18	40	< 0,02	< 0,01
18,1	24	50	< 0,02	< 0,01
24,1	30	60	< 0,02	< 0,01
30,0		80	< 0,03	< 0,015

* Geringere Rundlauftoleranzen mit der WNT HP (HighPrecision)-option auf Anfrage.

Unsere Profil-Spannzangen und Führungsbuchsen werden mit bis zu 7 Schnitten feinsterodiert. Dadurch garantieren wir Ihnen höchste Qualität bei gleichzeitig geringsten Rundlauftoleranzen.

Ihr Anspruch ist unser Bestreben. Deshalb sind die Toleranzen der WNT-Norm deutlich enger als die Standard-Toleranzen. Die Lebenszeit von Maschinenkomponenten steigt genauso wie die der Werkzeuge an.

Spezielle Formen

Durch eine Vielzahl von unterschiedlichen Anwendungen entsteht die Notwendigkeit, manche Produkte individuell auf die Prozesse anzupassen. Hierzu bieten wir Ihnen höchste Qualität nach Ihren Vorgaben an. Nutzen Sie unsere folgenden Möglichkeiten und lassen Sie sich Ihr Spannmittel herstellen:

Persönliche Beratung

Haben Sie Interesse an unseren Spannmittel-Optionen?

Dann stehen Ihnen unsere Anwendungstechniker im Außendienst gerne beratend zur Seite. Dies gilt natürlich auch für unsere technischen Berater im Innendienst, welche Sie unter unserer gebührenfreien Servicenummer erreichen.

Anfrage per Formular

Für den Fall, dass Sie uns eine Anfrage zu speziell angepassten Lösungen senden möchten, finden Sie einen ausführlichen Fragebogen auf unserer Homepage in unserem Downloadbereich. Füllen Sie ihn bitte sorgfältig aus und senden ihn per E-Mail oder ausgedruckt per Fax.
→ www.wnt.com/de/download/